

# Third harmonic generator

MODEL ATsG800

S/N 00023

INSTRUCTION MANUAL

DEL



MAR PHOTONICS

**Del Mar Photonics, Inc**

4119 Twilight Ridge

San Diego, CA 92130

tel: (858) 876-3133

fax: (858) 630-2376

[support@dmphotonics.com](mailto:support@dmphotonics.com)

<http://www.dmphotonics.com/>

## GENERAL SAFETY INFORMATION

In order to ensure the safe operation and optimal performance of the product, please follow these warnings in addition to the other information contained elsewhere in this document.

**WARNING:** If this instrument is used in a manner not specified in this document, the protection provided by the instrument may be impaired.

## TABLE OF CONTENTS

1. ACCESSORIES	3
2. INTRODUCTION	4
2.1. Introducing device	4
2.2. General information	5
3. SPECIFICATIONS	8
4. INSTALLATION AND ALIGNMENT	9
4.1. Unpacking the generator	9
4.2. Aligning the generator	11
4.3. Working with the tunable TH output	18
4.4. Working with the tunable SH output	20
5. REFERENCES	22

1. ACCESSORIES

<b>Part</b>	<b>Quantity</b>	<b>Note</b>
Box	1	Opto-mechanical box
Table clamp	4	Clamps for securing the Optical Unit on optical table
Manual	1	This document

## 2. INTRODUCTION

### 2.1) *Introducing device*

Third harmonic generator ATsG800 is developed for frequency tripling of tunable Ti-Sa radiation ( $\lambda=0.75-0.9 \mu\text{m}$ ) and frequency doubling of laser radiation in the range ( $\lambda=0.71-0.96 \mu\text{m}$ ). Device is based on second harmonic generation (SHG) and sum-frequency generation (SFG) techniques and provides stable radiation ( $\lambda=250-300 \text{ nm}$ ) in *fs* scale. ATsG800 provides a minimum TH pulse broadening at high conversion efficiency.

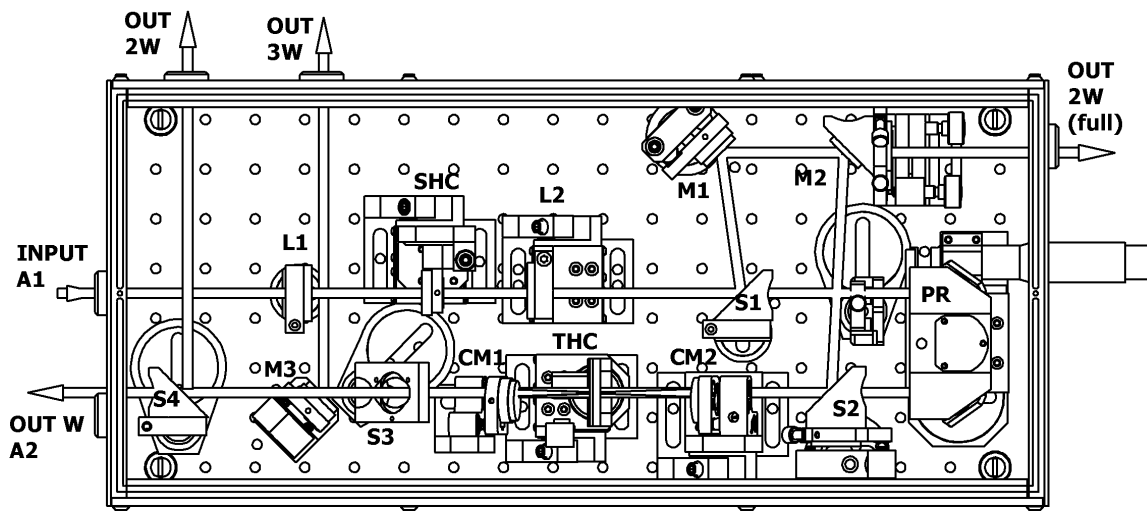

[Fig.1](#). The key diagram of TH generator

The basic scheme of generator is depicted on [Fig.1](#).

Conventional doubling scheme uses tight focusing to get better conversion efficiency into the SH radiation. An incoming fundamental (F) beam is focused by lens L1 onto SHC crystal (BBO, type I) and generates SH signal. Then F and SH beams are separated into two different paths by separator S1 that has a high transmittance for F beam and high reflectance for SH beam.

An adjustable optical delay with polarization rotator (PR) is used to make F and SH pulses coincident in time for SFG. The flip-mirror M2 in “up-state” acts like a mirror. In “down-state” it is used for emanating of the total SH radiation. PR

consisted of three mirrors is placed into F beam arm to convert horizontal polarization of the fundamental beam to vertical one. Then two beams after meeting each other at separator S2 are focused onto THC crystal by spherical mirror CM1 for SF (cascaded third harmonic) generation (BBO, type I). Spherical mirror CM2 is placed to recollimate the F, SH and TH beams. TH signal is separated from fundamental and SH ones by two-mirrors separator S3 and then SH beam is separated from F one by S4. Spherical mirrors CM1 and CM2 are used for achromatic focusing and as sequence for better recollimating of all beams.

TH generator consists of the following optical elements:

1. SHC crystal - BBO (type I) 1 mm thick crystal;
2. THC crystal - BBO (type I) 0.5 mm thick crystal;
3. Focusing lenses - L1, L2 (f=60 mm both);
4. Separators (S1, S2, S4)- high transparent for F radiation and high reflective for SH radiation (HR  $\lambda=350-450$  nm, HT  $\lambda=750-900$  nm);
5. M2, M3 – dielectric mirrors (for SH radiation at wavelength  $\lambda=350-460$  nm);
6. PR – polarization rotator (consisted of three dielectric mirrors  $\lambda=740-910$  nm);
7. Separator S3 - high reflective for TH radiation and high transparent for F and SH radiation;
8. CM1 dielectric spherical mirror (f=37.5 mm);
9. CM2 – aluminium spherical (f=50 mm) mirror;
10. M3 - dielectric mirror (HR  $\lambda=250-300$  nm).

## 2.2) *General information*

If the matter interacts with the high power laser radiation the material properties are changed by the incident field. In this case the induced polarization has the high components depending on the electrical field:

$$P = \chi^{(1)}(\omega)E(\omega) + \chi^{(2)}(2\omega)E(\omega)E(\omega) + \chi^{(3)}(3\omega)E(\omega)E(\omega)E(\omega) + \dots \quad (1)$$

The  $\chi^{(2)}$  is the tensor of second-order nonlinear optical susceptibility and it is responsible for second-harmonic generation (SHG) and sum-frequency generation

(SFG). Let's consider the generation of *Ti-Sa* second ( $\omega_2 = 2\omega_1$ ) and third harmonic ( $\omega_3 = 3\omega_1$ ) obtained by fundamental and SH radiation mixing ( $\omega_1 + \omega_2 = \omega_3$ ). Assuming the plane wave front and neglecting group velocity dispersion (GVD) and group velocity mismatch (GVM), the SH conversion efficiency can be written as:

$$\frac{I_2}{I_1} = \frac{2\pi^2 d^2 L^2 I_1}{\varepsilon_0 c n_1^2 n_2 \lambda_2^2} \text{Sinc}^2\left(\frac{|\Delta k|L}{2}\right), \quad (2)$$

where  $I_1$  and  $I_2$  are the fundamental and SH intensities, respectively,  $L$  – the length of the crystal,  $d$ - the dipole moment of the interaction,  $|\Delta k| = 2k_1 - k_2$  is a phase mismatch. In the case of type-I *oo-e* interaction in which the fundamental ordinary (*o*) wave produces extraordinary (*e*) wave, respectively, the phase-matching angle  $\theta$  of birefringent crystal can be easily derived from the equation:

$$|\Delta k| = 2\frac{\omega}{c}(n_e(\omega) - n_o(2\omega, \theta)) = 0. \quad (3)$$

The sum-frequency (SF) conversion efficiency can be written as

$$\frac{I_3}{I_1} = \frac{8\pi^2 d^2 L^2 I_2}{\varepsilon_0 c n_1 n_2 n_3 \lambda_3^2} \text{Sinc}^2\left(\frac{|\Delta k|L}{2}\right) \quad (4)$$

where  $I_3$ - SF intensity,  $I_1$  and  $I_2$  are the fundamental and SH intensities, respectively,  $L$  – the length of the crystal,  $|\Delta k| = k_1 + k_2 - k_3$  is a phase mismatch. In the case of type-I *oo-e* interaction phase-matching angle  $\theta$  of birefringent THC crystal can be obtained:

$$|\Delta k| = \frac{\omega}{c}(n_o(\omega) + 2n_o(2\omega) - 3n_e(3\omega, \theta)) = 0. \quad (3)$$

For example, the phase-matching angle for SF in BBO-type-I crystal is  $\theta = 44^\circ$  at  $\lambda_o = 0.8 \mu m$ .

If the ultra-short laser pulse sources are used the effects of group velocity mismatch (GVM) and group velocity dispersion (GVD) can seriously effect on SH pulse propagation. In case of exact phase matching fundamental pulse does not suffer losses and the SH electrical field at the end of crystal of the length  $L$  can be written as:

$$E_2(2\omega, t - \frac{L}{v_2}, L) = -i\chi^{(2)} \frac{\omega_2^2}{4c^2 k_2} \int_0^L E_1^2 \left[ t - \frac{L}{v_2} + z \left( \frac{1}{v_2} - \frac{1}{v_1} \right) \right] dz. \quad (4)$$

The term  $z \left( \frac{1}{v_2} - \frac{1}{v_1} \right)$  describes the longitudinal walk-off between the SH pulse and the F pulse owing to the different group velocities. The result is a broadening of the second harmonic pulse. Only for crystal lengths

$$L \ll L_D = \frac{\tau_p}{v_2^{-1} - v_1^{-1}}, \quad (5)$$

an influence of GV mismatch can be neglected.

The case of SFG is more complicated. If the thick crystals are used the duration of TH pulse generated in SF crystal can be written as:

$$\tau_3 = (\tau_1 + \tau_2) \frac{v_3^{-1} - v_1^{-1}}{v_2^{-1} - v_1^{-1}}. \quad (6)$$

For instance, for the BBO type-I crystal  $v_2^{-1} - v_1^{-1} = 317 \text{fs/mm}$ ,  $v_3^{-1} - v_1^{-1} = 725 \text{fs/mm}$  and assuming  $\tau_1 \approx \tau_2 \approx 50 \text{fs}$  we obtain  $\tau_3 = 220 \text{fs}$  for sufficient a long crystal. It means that the TH must be broadened in 4 times compare with the fundamental pulse duration. But using thinner crystals is not so attractive because of the small conversion efficiencies.

However the focusing femtosecond pulses with lenses can reduce the effect of GVM due to the angular dispersion. When achromatic phase matching is considered, an angular dispersion of the pulse allows phase matching and GVM simultaneously. In this case the generation of SH and TH pulses as short as fundamental pulses is available.

# ATsG800 outline drawing

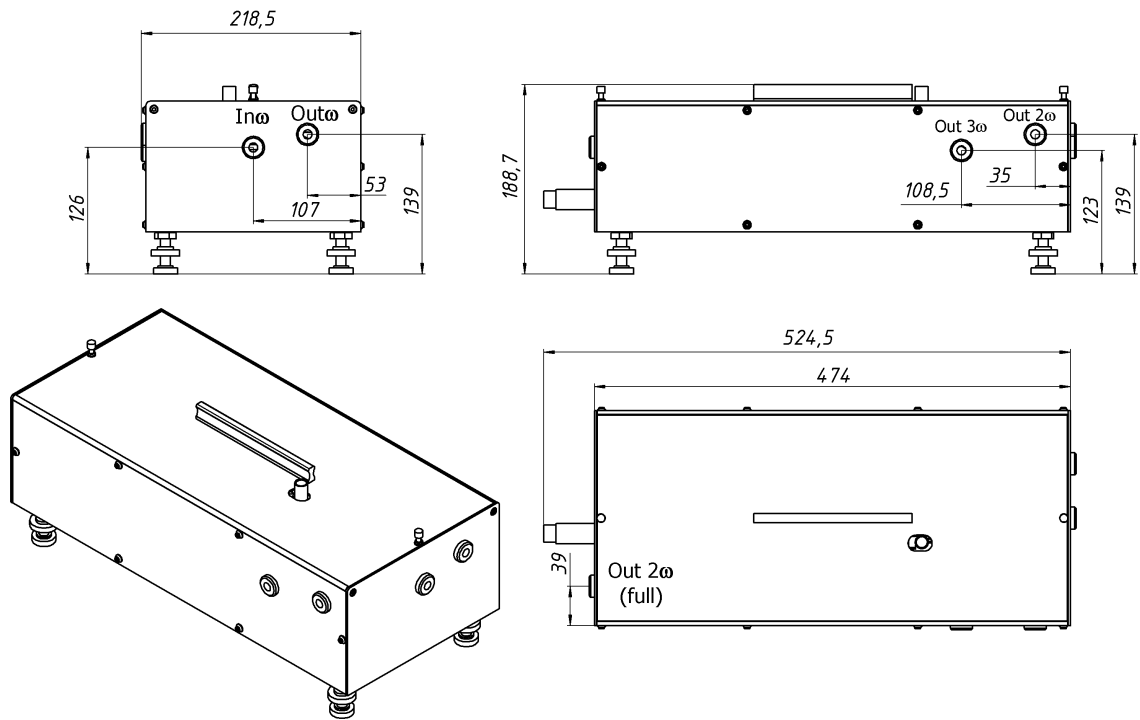

Fig.2. Outline drawings.



### 3. SPECIFICATIONS

- Pulse width - > 20 fs
- TH efficiency \* - > 7 %
- SH efficiency - >20 % (total output\*\*)
- Input beam size - <2 mm
- Temporal broadening - For TH pulse < 200 fs  
For SH pulse < 100 fs
- Input polarization - Linear- horizontal
- Output TH polarization - Linear- horizontal
- Output SH polarization - linear- vertical
- Output fundamental beam polarization - linear- vertical
- Input wavelength - 710 - 960 nm
- Output TH wavelength - 250 – 300 nm
- Output SH wavelength - 355 – 480 nm
- Dimensions - 475mm x 220mm x 190mm

\* - at input power > 1 W

\*\* - at  $\lambda=710-960$  nm (just after the flip-mirror)

## 4. INSTALLATIONS AND ALIGNMENT

### *4.1) Unpacking generator*

Your generator was packed with great care and all containers were inspected prior to shipment: the generator left Del Mar Photonics in good condition. Upon receipt of your laser, immediately inspect the outside of the shipping containers. If there is any major damage, such as holes in the box or cracked wooden frame members, insist on that a representative of the carrier should be present when you unpack the contents.

Carefully inspect generator box as you unpack it. If you notice any damage, such as dents, scratches or broken knobs immediately notify the carrier and your Del Mar Photonics Sales representative.

Open the cover of the box head and remove the bags which covering the elements of generator and fixing elements which are used for transport. Do it very carefully, try not to misalign the generator, and damage optical elements during this procedure.

### *4.2) Aligning the generator*

- 1) Install optical unit of the generator on the optical table horizontally. Adjust the height of the generator using the leg-screws so that the box will be parallel to the table surface.
- 2) Attach the optical unit to the table using clamps.
- 3) Remove lenses L1, L2 loosening the M4 screws before (see. [Fig.3](#)).
- 4) **Block the beam between the crystal THC and spherical mirror CM1! (Fig.4).**
- 5) Make the pump beam passing through the aperture A1 and the aperture of flip-diaphragm.

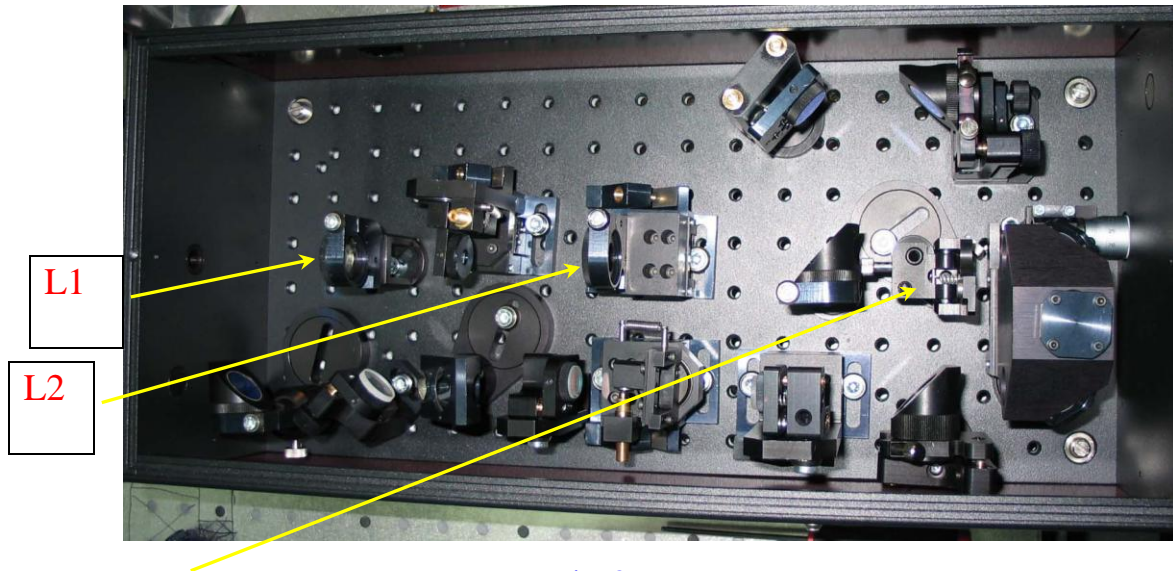

Fig.3.

Flip  
diaphragm

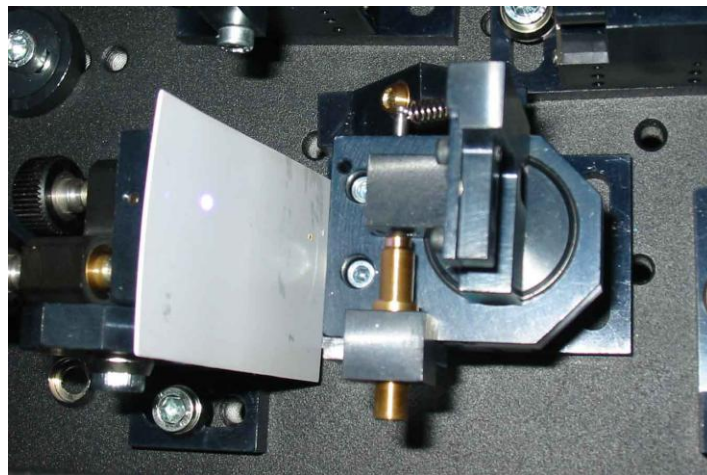

Fig.4.

- 6) Install the lens L1. **Be careful! Block the pump F beam before the crystal SHC while inserting or removing L1.**
- 7) Install the lens L2. Check that the pump beam passes through the flip-diaphragm properly. If it is not so try to rotate lens L2 in holder around its rotational axis to reach coincidence of beam spot and diaphragm D. *If it is not yet you need to loose the screws of L2 holder and shake L2 carefully to make the beam passing through the flip-diaphragm properly (Fig.5).*

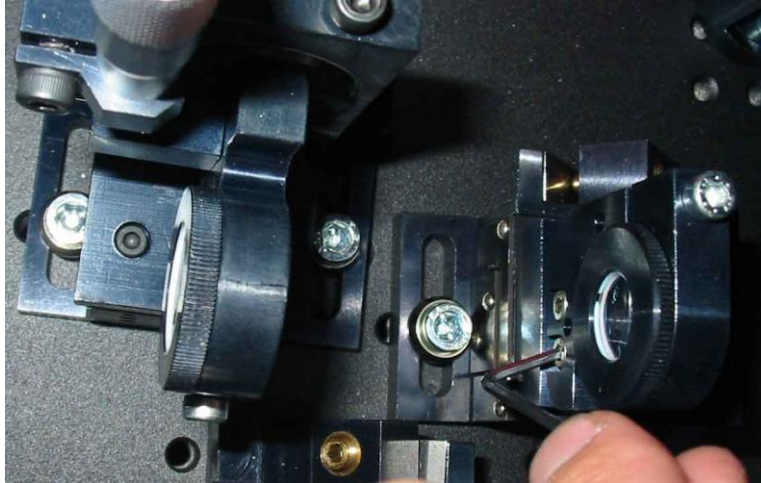

Fig.5.

- 8) Remove the diaphragm from the aperture A1 and flip the flip-diaphragm to “down-state”.
- 9) Flip the mirror M2 so that it will be in “down-state” (parallel to the table) (Fig.6). Remove the gag from the 2W (full) output.

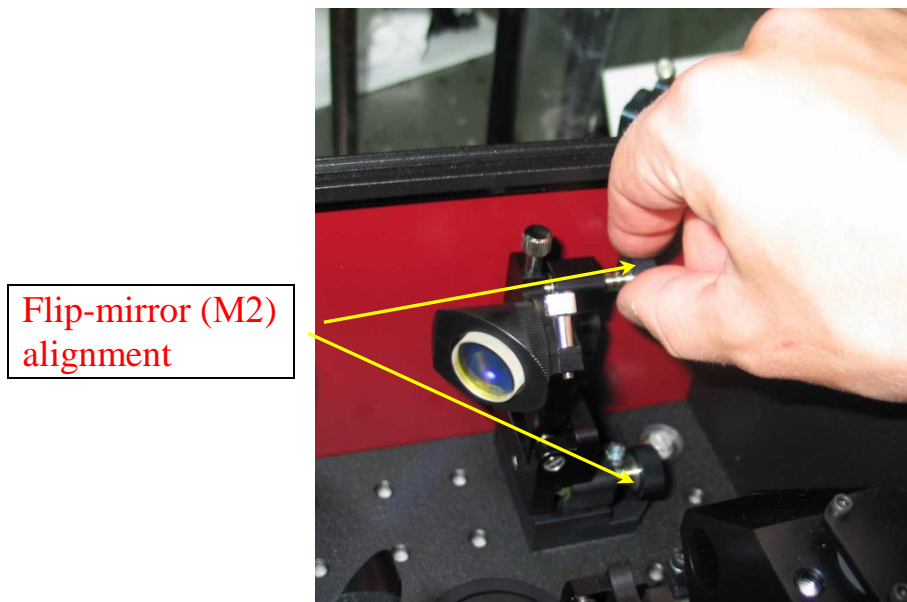

Fig.6.

- 10) Install a power meter in SH beam. Measure the SH power.
- 11) Adjust a micrometer screw of SH holder (to incline the angle of SH crystal) to get the maximal SH intensity (Fig.7).
- 12) Adjust a screw on SH table (to move SH table along the focus of the F beam) to get more energy in SH signal (Fig.7).

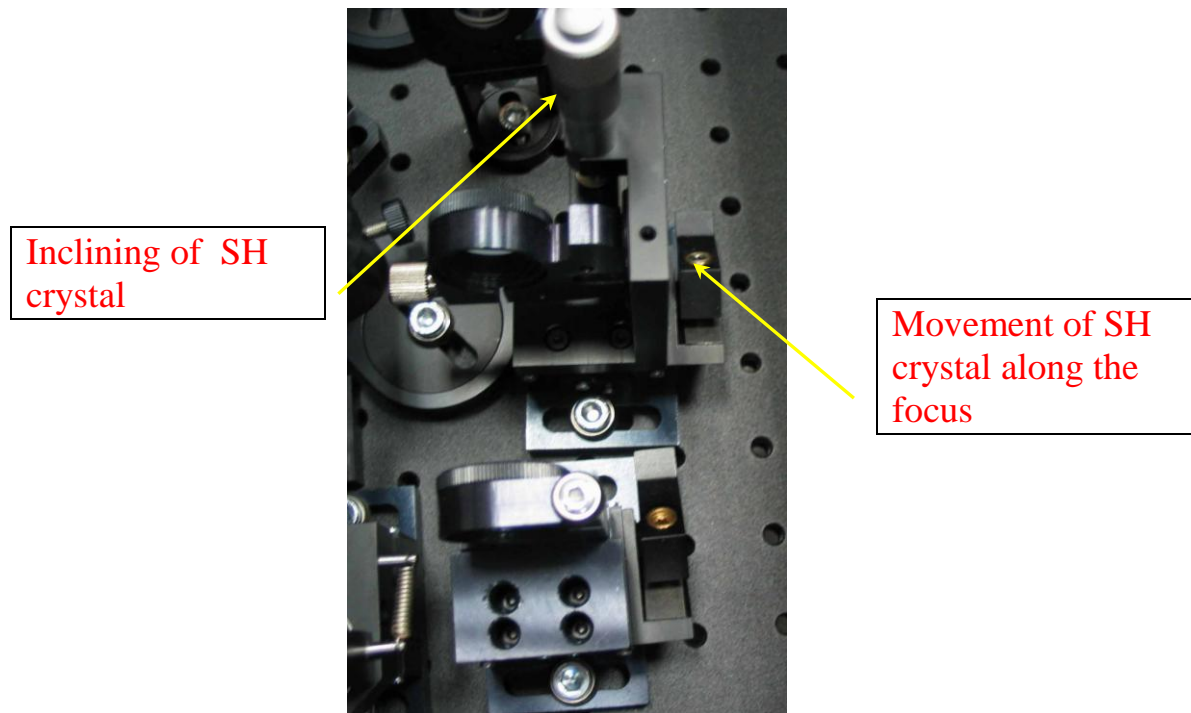
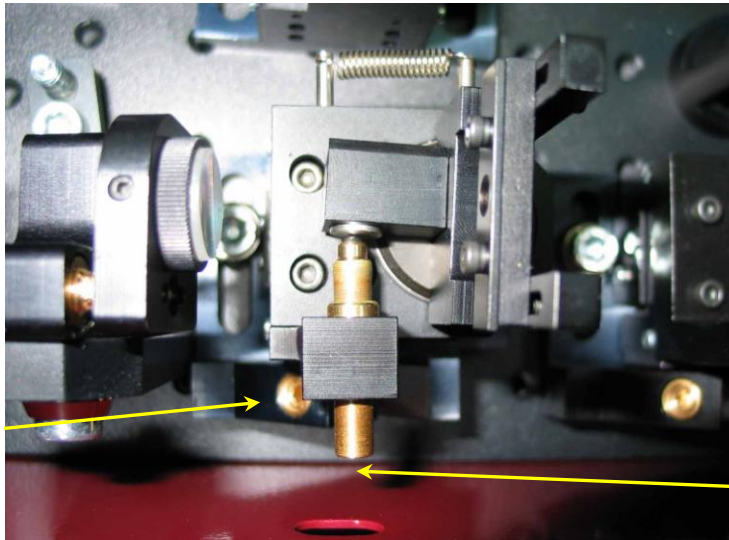

Fig.7.

- 13) Get the flip-mirror M2 to the “up-state” back. Cancel the block before the THC.
- 14) Now you can see the TH signal. **Attention! The generator left Del Mar Photonics aligned at the fundamental wavelength  $\lambda=0.845 \mu\text{m}$ .** So we recommend you to start from this wavelength. If the TH signal doesn't appear go to the step 19).
- 15) Install a power meter in TH beam. Measure the TH power.
- 16) Adjust a long screw-knob on TH table (to incline the angle of TH crystal) to get the maximal TH intensity (Fig.8).
- 17) Adjust a TH table screw (move TH table along the focus) to get more energy in TH signal (See Fig.8).
- 18) Adjust (slightly) the micrometer screw of PR (delay line) to get more TH energy.

Movement of TH crystal along the focus



Inclining of TH crystal

Fig.8.

- 19) *If you doesn't see TH signal: check the micrometer of PR (the "right" position must be 7 mm and 722-724 mkm).*
- 20) *Check that F and SH beams are collinear. Insert straight behind S2 the black steel plate. Two beams spots must be coincident on it. If not try to adjust the M2 screws for aligning (Fig.6)*

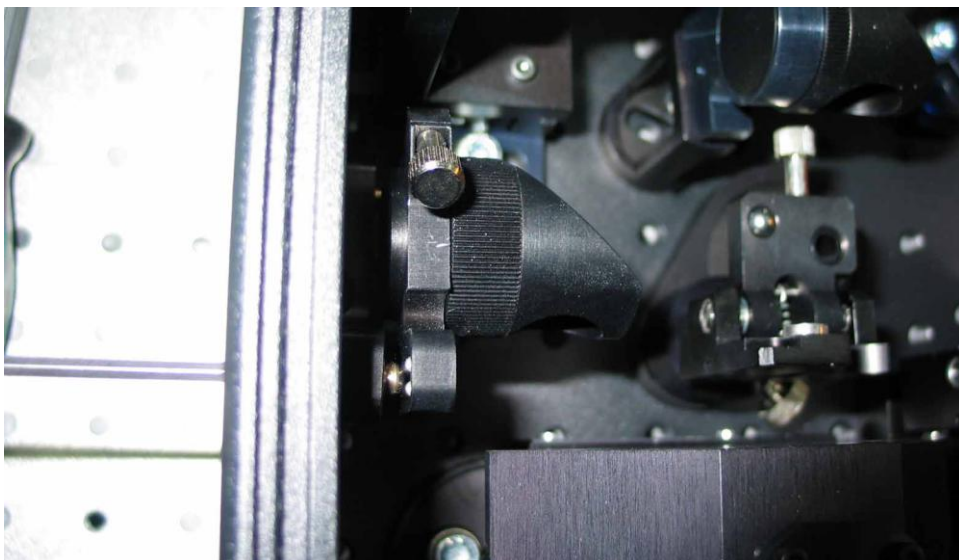

Fig.9.

- 21) *Insert before the S4 the black steel plate. Check that two beams are coincident as well as behind S2. If not try to adjust the screws of S2 to make two beams collinear (pass a wrench through the holes) (Fig.9).*
- 22) *Repeat steps 20 and 21 until two beams will be completely collinear.*
- 23) *Check that F beam goes through the S3 and S4 and aperture A2 properly. F beam must strike near at the center of aperture A2. SH beam reflected from S4 must pass through the output freely. If not adjust the screws of CM2 holder (Fig.10) to direct SH beam. Remove the gag A2 for the output of F the beam.*

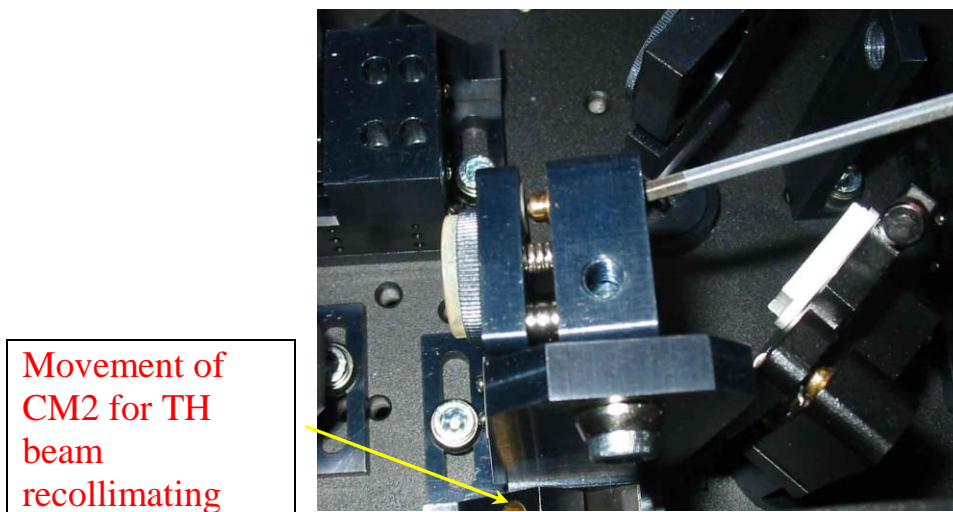

Fig. 10.

- 24) *Check that TH beam goes through the output properly. You can align the M3 mirror to direct TH to the center of the hole. Use the special auxiliary screw (applied) to adjust the bottom screw of M3 mirror.*
- 25) *Align slightly the mirrors M2 and S2 to get more energy in TH signal.*
- 26) *Repeat steps 16-18.*
- 27) *You can adjust a screw of CM2 table (Fig.10) to improve the quality of TH beam.*
- 28) *Now the generator is ready for working.*

### *4.3) Working with the tunable TH output*

If you tune the F beam from TiSa laser to another wavelength you need to realign the generator.

- 1) Install the power meter into the SH beam (output of residual SH).
- 2) Repeat steps №11 and №12 of previous paragraph. Maximize the SH intensity. Rotate screw in clock-wise direction to tune higher 800 nm and in anticlock-wise direction for tuning lower 800 nm.
- 3) Maximize the TH signal according to the steps 16-18 of previous paragraph. Rotate screw in clock-wise direction to tune higher 800 nm and in anticlock-wise direction for tuning lower 800 nm.
- 4) Adjust slightly the secret screws of M3 and S2 to get more energy in TH signal.



*NOTE: Occasionally, it may be necessary to clean the optics of TH generator. The best method to clean surfaces is to first block the pump beam and then blow excess particles from the surface. If the mirrors are severely contaminated you may clean it with acetone and very soft tissue.*

*WARNING: Don't clean the BBO crystal with acetone or alcohol. Use only blowing to clean the surface of crystal.*

## REFERENCES

1. J.-C. Diels and W. Rudolph, *Ultrashort Laser Pulse Phenomena: Fundamentals, Techniques, and Applications on a Femtosecond Time Scale* (Academic, San Diego, Calif., 1996), pp. 365-399.
2. R. C. Miller, Phys. Lett., **26**: 177-178 (1968).
3. S.A. Akhmanov, A.S. Chirkin, and A.P. Sukhorukov, Sov. J. Quantum Electron., **28**, 748-759 (1968).
4. W.H. Glenn, IEEE J. Quantum Electron., QE-**5**, 281-290 (1969).
5. R.C. Eckardt and J. Reintjes, IEEE J. Quantum Electron., QE-**20**, 1178-1187 (1984).
6. N.C. Kothari and X. Carlotti, J. Opt, Soc. Am. B, **5**, 756-764 (1988).
7. D. Kuehlke and U. Herpers, Opt. Commun, **69**, 75-80 (1988).
8. G. Szabo and Z. Bor, Appl. Phys. B, **50**, 51-54 (1990).
9. A. Stabinis, G. Valiulis, and E.A. Ibragimov, Optics Comm., **86**, 301-306 (1991).
10. S.H. Ashworth, M. Joschko, M. Woerner, E. Riedle, and T. Elsaesser, Opt. Lett. Vol. **20**, No. 20, 2120 (1995)
11. A. Furbach, T. Le, C.Spielmann, F.Krausz, Appl. Phys. B **70**, S37 (2000).

