

# Mode-Locked Femtosecond Titanium:Sapphire Laser

Model Trestles – 50

---



**Del Mar Photonics, Inc**  
4119 Twilight Ridge  
San Diego, CA 92130  
tel: (858) 876-3133  
fax: (858) 630-2376  
[support@dmphotonics.com](mailto:support@dmphotonics.com)  
<http://www.dmphotonics.com/>

# TABLE OF CONTENTS

<b>1. INTRODUCTION</b> .....	<b>4</b>
TITANIUM-DOPED SAPPHIRE .....	4
<b>2. LASER SAFETY</b> .....	<b>6</b>
SAFETY PRECAUTIONS .....	6
<b>3. LASER DESCRIPTION</b> .....	<b>9</b>
GENERAL OVERVIEW .....	9
OUTLINE DRAWING .....	10
PUMPING OPTIMIZATION .....	11
TRESTLES-50 LASER DESCRIPTION .....	12
<i>Pump laser</i> .....	12
<i>The folded cavity</i> .....	12
<i>Wavelength turning characteristics</i> .....	16
<i>Wavelength selection at femtosecond regime</i> .....	17
<i>Wavelength selection at CW regime</i> .....	17
<i>Pulse width selection</i> .....	18
<i>Description of componets</i> .....	18
<b>4. LIST OF ACCESSORIES</b> .....	<b>19</b>
<b>5. INSTALLATION</b> .....	<b>20</b>
UNPACKING YOUR LASER.....	20
PLACEMENT OF TRESTLES-50 LASER HEAD .....	20
<b>6. ALIGNMENT</b> .....	<b>22</b>
ALIGNMENT OF CONTINUOUS WAVE Ti:SAPPHIRE LASER .....	22
ALIGNMENT OF MODE LOCKED TI:SAPPIRE LASER .....	33
<b>7. DAY-TO-DAY OPERATION</b> .....	<b>42</b>
<b>8. POSSIBLE PROBLEMS</b> .....	<b>43</b>
<b>9. ELECTRONICS MODULE (VERSION LS-6.0)</b> .....	<b>44</b>
INSTALLATION AND ALIGNMENT .....	47
<b>10. GENERAL INFORMATION ABOUT CONTROLLER</b> .....	<b>50</b>
<b>11. CONNECTION OF THE CONTROLLER</b> .....	<b>52</b>
<b>12. MANUAL MODE OF THE CONTROLLER</b> .....	<b>53</b>
<b>13. DESCRIPTION OF “TUNELA”</b> .....	<b>53</b>
MAIN WINDOW.....	55
MAIN MENU .....	58
STEPPING MOTOR PROPERTIES DIALOG BOX .....	59
EDIT CALIBRATION DIALOG BOX .....	60
FAVORITE WAVELENGTHS DIALOG BOX .....	62
STEPPING MOTORS DRIVER MANAGER DIALOG BOX .....	62
STEPPING MOTORS SETUP DIALOG BOX.....	64
STEPPING MOTORS CONFIGURATION DIALOG BOX (ADVANCED TOPIC).....	65

SETTING UP FROM SCRATCH (ADVANCED TOPIC) .....	65
<b>14. DESCRIPTION OF "MOTOR CONTROL PROGRAM FOR SMC245-1V2" .....</b>	<b>68</b>
CALIBRATION OF THE DEVICE .....	69
THE MOTION OF THE STEPPING MOTOR .....	70
FAST CONTROL MODE .....	72
<b>15. INSTALLING HARDWARE DRIVERS AND SOFTWARE .....</b>	<b>74</b>
INSTALLING HARDWARE DRIVERS.....	74
INSTALLING "TUNELA" .....	80
INSTALLING "MOTOR CONTROL PROGRAM FOR SMC245-1V2" .....	80
<b>16. START "TUNELA" .....</b>	<b>81</b>
<b>NOTES.....</b>	<b>82</b>

# 1. INTRODUCTION

## TITANIUM-DOPED SAPPHIRE

Titanium-doped sapphire (Ti:Sapphire) is a solid state laser medium capable of tunable laser operation over broad range of near infrared (IR) wavelengths. Because of its broad absorption band in blue and green, the energy for lasing process can be supplied by standard continuous wave (CW) argon ion laser or CW 532 nm, high-power, diode-pumped solid state laser as opposed to an electrical discharge or flash lamp that supplies broad-band excitation.

With properly chosen optics, the Ti:Sapphire laser delivers a range of wavelengths from 690 nm to 1080 nm, and pulse durations  $<10$  fs.

Solid-state mode-locked lasers produce femtosecond light pulses using Kerr lens mode-locking (KLM) principle of operation and continuous wave pumping sources. KLM principle combines self-focusing nonlinear optical effect and aperture effect together to reach the shortest optical pulses. This Kerr self-focusing effect leads to slight changes in the spatial intensity profile of the resonator mode in laser oscillators. As a consequence, by introducing an intracavity aperture, a power-dependent loss can be created. Owing to the quasi-instantaneous response of nonresonant Kerr nonlinearities, the amplitude modulation induced by self-focusing is able to simulate ultrafast saturable-absorber action and support pulse formation down to the femtosecond regime in solid-state lasers that have long gain-relaxation times. The gain bandwidth of

solid state laser materials such as Ti:Sapphire extends over  $>200$  nm and has the potential for supporting pulses of less than 10 fs. The pulse duration from these lasers is determined by critical interplay between intracavity self-phase modulation in media, and negative group delay dispersion.

Trestles-50 femtosecond laser head contains the Ti:Sapphire rod and the optics that form the resonator cavity.

Del Mar Photonics guarantees that provided laser was tested and it is suitable for the Kerr lens mode-locked operation. On the one hand, the laser installation without the help of the manufacturer requires some experience of the user in laser physics. But on the other hand, by working with our laser you will gain experience in ultrafast laser technology.

## 2. LASER SAFETY

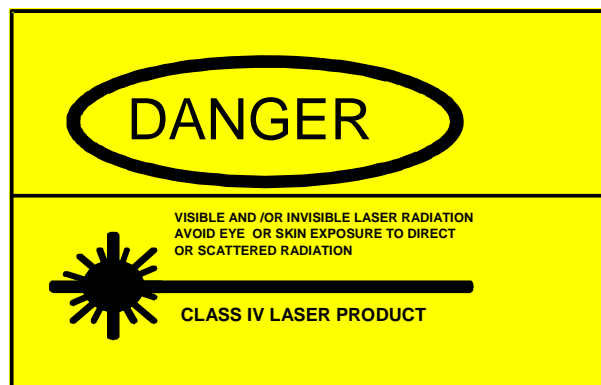
Trestles-50 and its pump laser are Class IV –high-power lasers, whose beams are, by definition, safety and fire hazards. Take precautions to prevent exposure to direct and reflected beams. Diffuse as well as secular reflections cause severe skin or eye damage.

Trestles-50 laser emits CW and pulsed infrared radiation; it is extremely dangerous to the eye. Infrared radiation passes easily through the cornea, which focuses it on the retina, where it can cause instantaneous permanent damage.

### SAFETY PRECAUTIONS

- Wear protective eyewear at all times; selection depends on the wavelength and intensity of the radiation, the conditions of use, and the visual function required. Protective eyewear vendors are listed in the *Laser Focus World*, *Laser Optronics*, and *Photonics Spectra* buyer's guides. Please use safety instructions of your pump laser and follow their recommendations in your work.
- Maintain a high ambient light level in the laser operation area. This keeps the pupil constricted, thus reducing the possibility of eye damage
- Keep the protective cover on the laser at all times.
- Avoid looking at the output beam; even diffuse reflections are hazardous. Keep all beams below eye level always. Never look in the plane of propagation of the beams.
- Avoid wearing jewelry or other objects that may reflect or scatter the beam while using the laser.

- Use an infrared detector or energy detector to verify that the laser beam is off before working in front of the laser.
- Operate the laser at lowest beam intensity possible, given the requirements of the application.
- Expand the beam whenever possible to reduce beam power density.
- Avoid blocking the output beams or its reflection with any part of the body.
- Establish a controlled access area for laser operation. Limit to those trained in the principles of laser safety.
- Post prominent warning signs near the laser operation area (*Fig. 1*).



*Fig. 1 Standard safety warning sign*

- Provide enclosures for beam paths whenever possible.
- Set up shields for secular reflections.
- Set up an energy absorbing target to capture the laser beam, preventing unnecessary reflections or scattering.

Be very careful while executing any step of the alignment. Avoid any exposure to the direct and reflected laser beams. Direct and reflected laser radiation from pump laser and Ti:Sapphire laser can cause serious eye damage. Remember that Ti:Sapphire radiation is invisible or looks like red laser radiation of low intensity. However, it is

dangerous even at lowest intensity. Intense incoherent luminescence is emitted from the Ti:Sapphire rod also.

We recommend using protective boxes covering all elements outside of the Ti:Sapphire laser.

Follow the instructions listed in this manual for safe operation of your laser.



## 3. Laser description

### GENERAL OVERVIEW

The Trestles-50 laser head contains the Ti:Sapphire rod and optics that form the oscillator cavity. Elements include pump beam mirrors, laser rod, focusing lens and mirrors, and output coupler (OC), high reflectors (HR), beam folding mirrors, prisms as dispersion control elements and slit as spectral turning element.

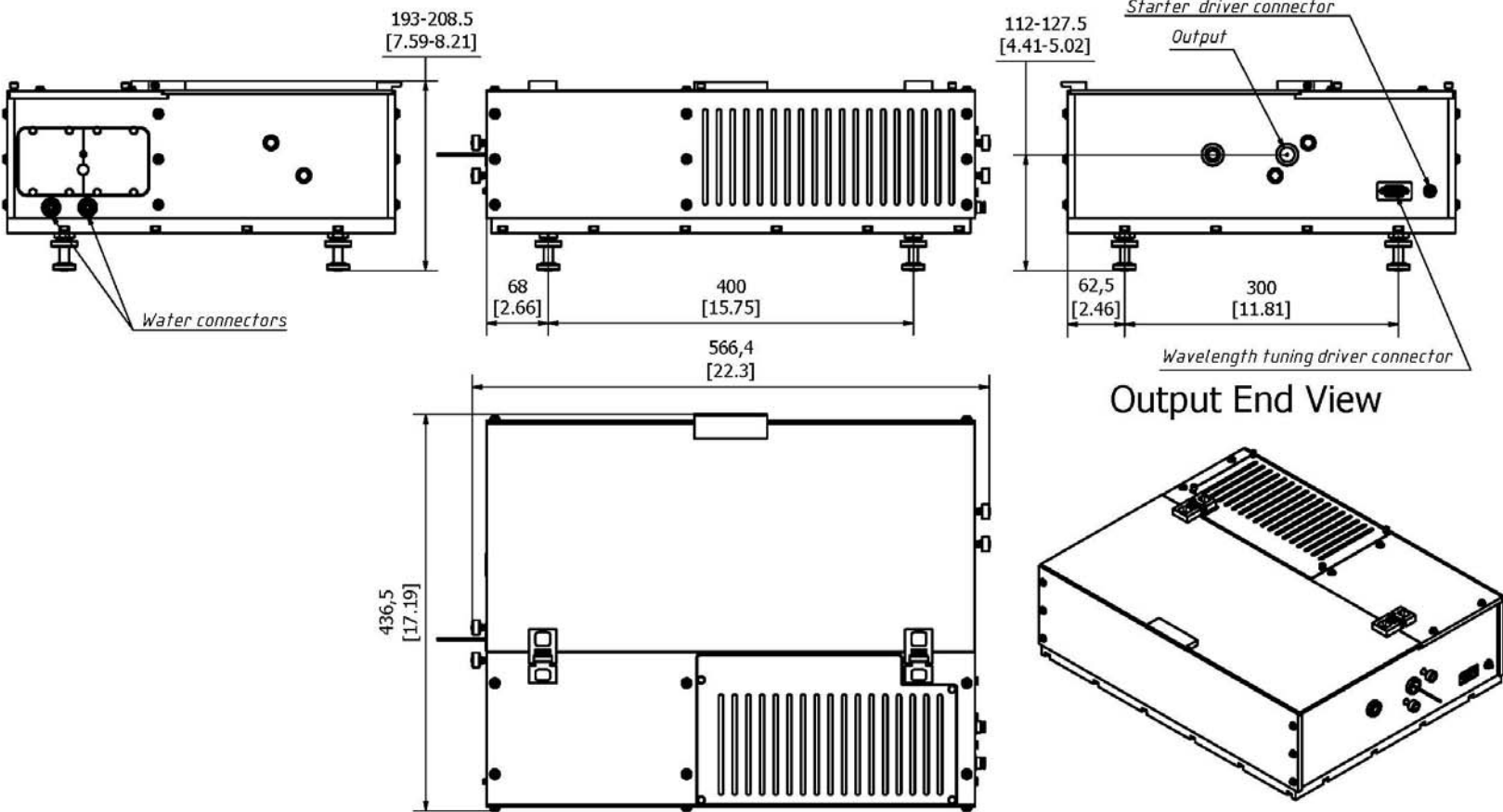
Connections to the laser (*Fig. 2*) include cooling water, power and control from "Electronics Module" (optionally), power and slit driver module (optionally) and power and birefringent filter driver module (optionally).

#### *Option:*

*The Electronics module enclosed with the laser consists of the pulse detection circuit and driver circuits for electromechanical starter. All indicators and controls are located on the front and upper panel. One cable connects it to laser head, the other pump cable and BNC cable may be connected to customer's oscilloscope.*

*Slit driver module enclosed with the laser consists of circuits for moving slit and prism inside the laser head.*

Outline drawing



Dimensions in millimeters [inches]

Fig. 2 Outline drawing

For continuous-wave (CW) pumping, there is one basic requirement for lasing action: the unsaturated round-trip CW gain must exceed the round trip loss from all sources. The CW gain is obtained by having a high inversion density and an adequate length of Ti:Sapphire material. The high inversion density comes from having a high pump intensity and high  $Ti^{3+}$  ion concentration. Losses in the Ti:Sapphire laser come from losses in mirror coatings and polished surfaces, and what is more important, the residual loss in the Ti:Sapphire material itself. This loss is proportional to the rod length and varies with the  $Ti^{3+}$  concentration, generally increasing as the  $Ti^{3+}$  concentration increases.

Unlike a dye laser, the pump illumination in Ti:Sapphire laser must be collinear with the cavity mode over a relatively long length of laser rod. Continuous, high inversion density over the entire volume of a rod several millimeters in diameter is difficult to achieve. To circumvent this problem, the pump light is focused to a narrow line within the rod and the oscillating laser mode is similarly focused and overlapped within the same volume – a technique known as longitudinal pumping. The output beam is then collimated and expanded to normal size. The residual pump beam is dumped through the second cavity focus mirror.

## TRESTLES-50 LASER DESCRIPTION

### PUMP LASER

Because of its broad absorption band in blue and green, energy for lasing process can be supplied by standard continuous wave (CW) argon ion laser or CW 532 nm, high-power, diode-pumped solid state laser. It is very important to note that pump laser should work in TEM<sub>00</sub> mode.

For pumping the Trestles-50 laser a pump laser operating in TEM<sub>00</sub> transverse mode regime with output power between 3 - 8 Watts should be used. CW 532 nm, high-power, diode-pumped solid state laser from *Laser Quantum* Opus and Finesse Series are used in the Trestles-50F. These pump lasers generate a near-diffraction limited, highly stable beam at 532nm. Capable of delivering >3W of power, these lasers are the most compact lasers in its class. They have highly sophisticated digital electronics. You will find extended information in the pump laser's owner manual.

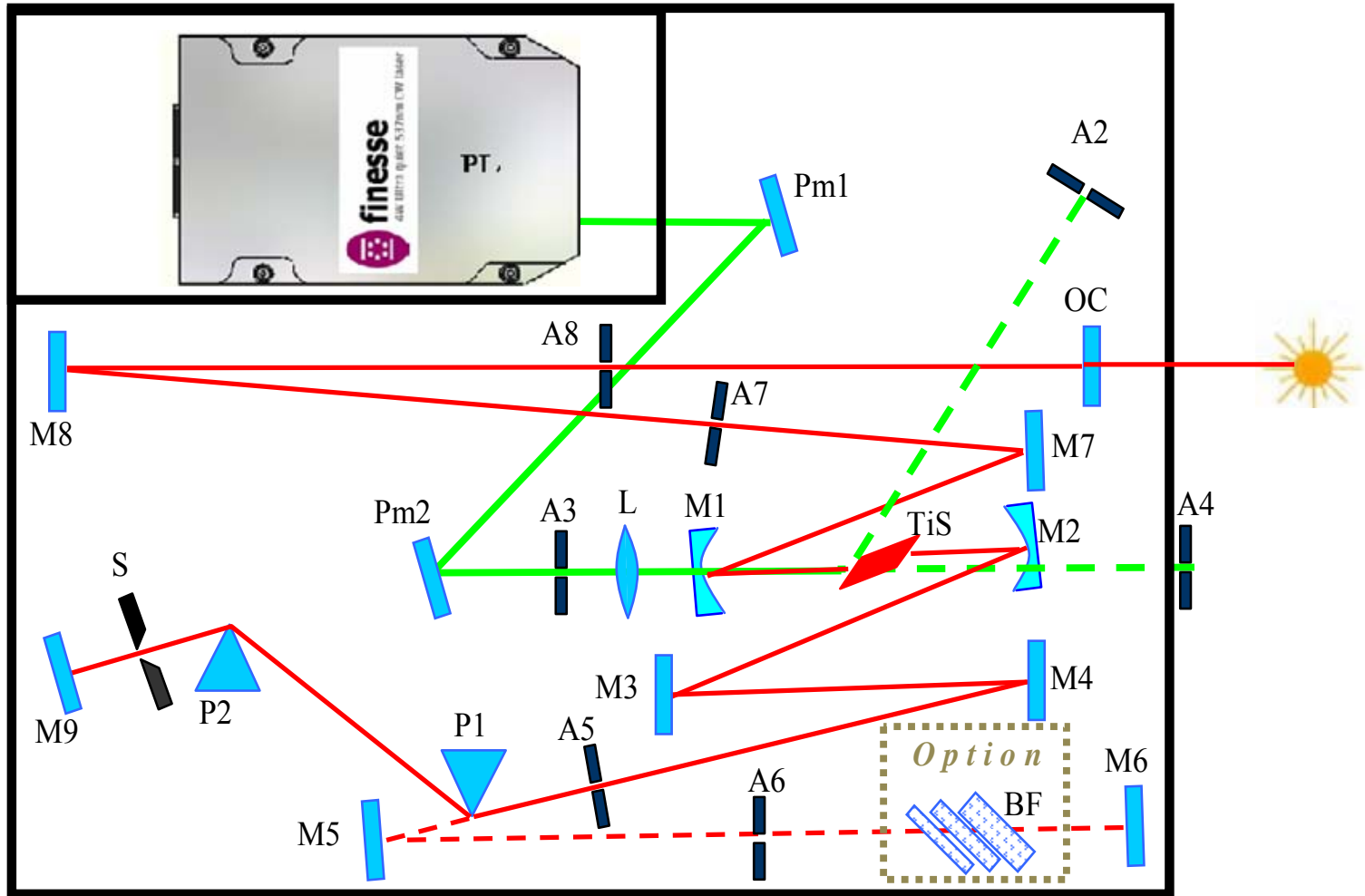
### THE FOLDED CAVITY

Del Mar Photonics modeled, analyzed and optimized the cavity design for optimum performance in minimal space. The result was a 10-mirror folded cavity (*Fig. 3* and *Fig. 4*). This scheme incorporates pump laser (PL), 10-mirror cavity (M1, M2, M3, M4, M5, M6, M7, M8, M9 OC), Ti:Sapphire crystal (TiS), lens for focusing of pump radiation (L), two prisms (P1 and P2) , slit (S). The transmission of the OC output mirror is optimized depending on the pump power and is between 0.05 and 0.15 (at 3 W or 6 W pump power respectively). The auxiliary M5 and M6 mirrors are used to facilitate tuning of the femtosecond cavity (formed by M1, M2, M3, M4, M7, M8, M9, OC). In this version of the Trestles-50 the slit and P2 prism translations stages are combined on one translation unit.

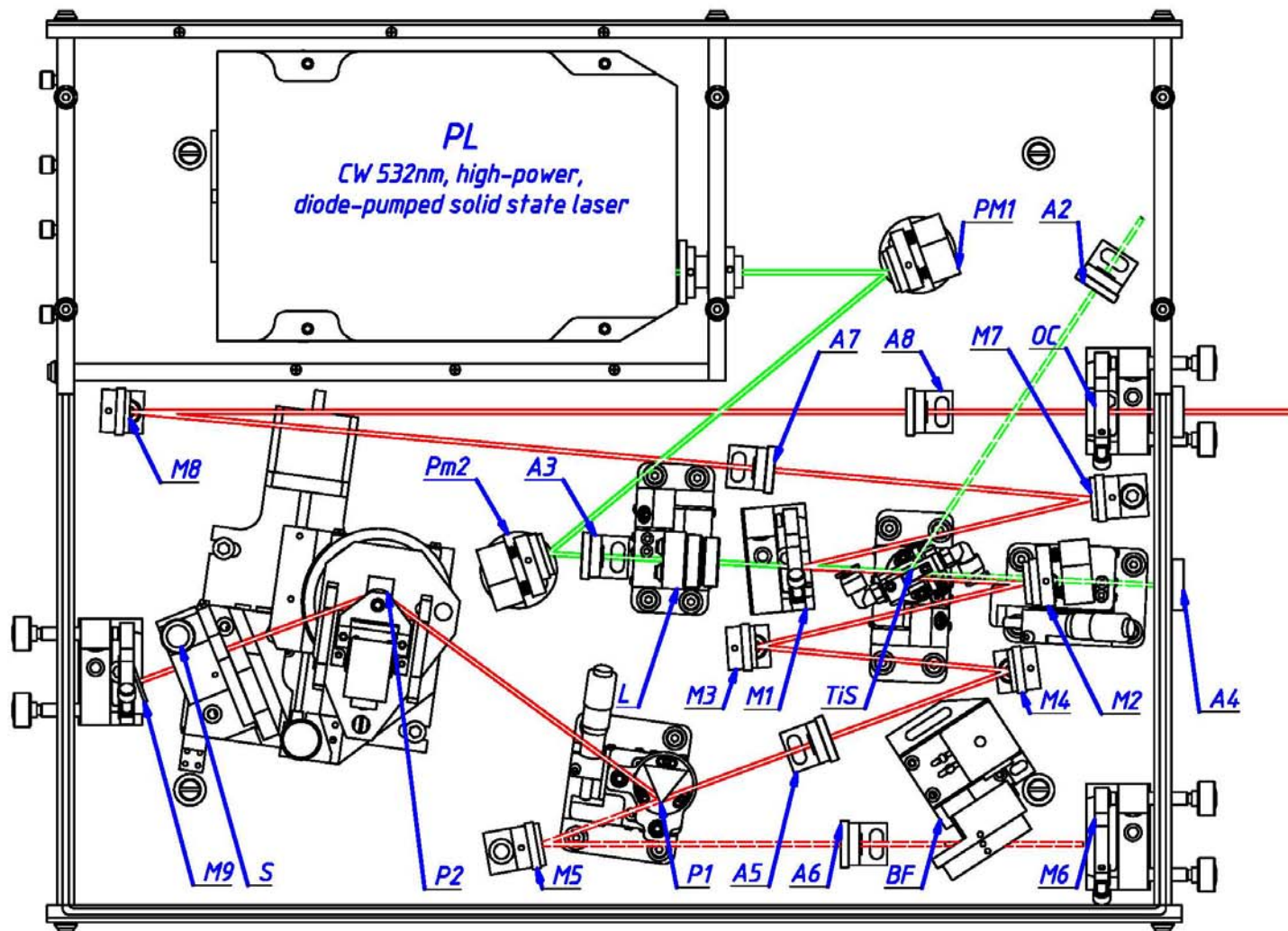
*Option.*

*Del Mar Photonics has designed the laser in such a way that it can operate either in mode-locked tunable regime or in CW tunable regime. This can be achieved by inserting a 3-plate birefringent filter (BF) as spectral tuning element, into the auxiliary arm между зеркалами M5 и M6. The plates in the filter are birefringent plates with spatially calculated thickness. The filter is a very delicate element and can be aligned only at the factory. The birefringent filter inside the cavity selects the wavelength for which the filter inserts minimal losses. By rotating the filter you are changing the wavelength with minimal insertion losses. At this case CW resonator will consist of mirrors M1, M2, M3, M4, M5, M6, M7, M8, OC. To switch between the CW and femtosecond cavities simply insert or remove the prism into or out of the beam path between the M4 and M5 (Fig. 3 and Fig. 4).*

In folded cavities where astigmatism is not eliminated, output beams are elliptical and hard to focus. But by carefully choosing the angles of the cavity focus mirrors and rod length, astigmatism in Trestles-50 output beam is virtually eliminated.



*Fig. 3 Basic Layout of Trestles-50*



*Fig. 4 Schematic setup of Trestles-50*

## WAVELENGTH TURNING CHARACTERISTICS

Due to the Ti:Sapphire rod is birefringent, uninterrupted tuning is achieved when the c – axis of the rod is aligned coplanar with the polarization of the electric field within the cavity. Since the Ti:Sapphire rod and prism surfaces (*option: birefringent filter plates' surfaces*) represent a total of six (8) Brewster's angle surfaces, the polarization within the cavity is largely determined by the orientation of these surfaces. Furthermore, cavity losses are minimized and tuning is optimized when all these surfaces are accurately aligned at Brewster's angle. The Trestles-50 laser uses a proprietary Ti:Sapphire rod holder that orients the rod surfaces at Brewster's angle and allows the c axis of the rod to be aligned coplanar to the electric field vector. This technique compensates for unavoidable errors in rod orientation that occur when the rod is cut and polished. Wavelength tuning range of the Trestles-50 laser is 720 nm to 950 nm with two sets of optics (i.e. the rod and system are capable of continuous turning over this range in a femtosecond regime). *Option: If you purchased the optional birefringent filter, you will achieve gradual wavelength tuning also in CW mode.* The laser comes with the optics set(s) you specified with your order.



#### WAVELENGTH SELECTION AT FEMTOSECOND REGIME

The femtosecond Trestles-50 laser is wavelength tuned using a prism sequence and a slit. This sequence provides a region in the cavity where the wavelengths are spatially spread. A variable slit is located in this dispersed beam. The output wavelength is tuned by changing the position of the slit in the horizontal plane. The width of the slit can also be changed so that the bandwidth (and, hence, the temporal width) of the output pulse can be varied. This simple, straight-forward method covers the entire Ti:Sapphire range for ultrashort pulses.

#### WAVELENGTH SELECTION AT CW REGIME(OPTION)

*Classic birefringent Lyot filter consist of several numbers of plates and polarizers between of it. However when the filter is used inside the optical cavity of the laser role of the polarizers play surfaces of the plates, because Brewster losses from the plate and other intracavity elements are usually sufficient to produce the polarizing effect. The birefringent Lyot filter in your laser is made from three quartz birefringent plates, with definite ratio of the plates thickness. Because the plates are birefringent, the ordinary and extraordinary polarization components of a light beam experience a different refractive index and thus have a different phase velocity. Therefore, the polarization state of light with an arbitrary wavelength will in general be modified after a passage through the filter plate, and this causes a loss of optical power in a surface of the subsequent plate. For certain wavelengths, however, the optical path length difference is an integer multiple of the wavelength, so that the losses are very small. By rotating the plates, one can shift the wavelengths of the transmission peaks. To decrease undesirable losses at plate's surfaces the filter is placed at Brewster angle to the beam. Rotating of the birefringent filter can be done under manual regime, and with help of PC and driving program (optional).*

#### PULSE WIDTH SELECTION

The pulse width tuning characteristics of the Ti:Sapphire laser are influenced by two factors: those inherent in the Ti: sapphire material itself and those from cavity parameters. While we cannot readily modify the Ti:Sapphire material to change pulse width, we can modify the net group velocity dispersion (GVD). The optical components in the laser cavity introduce positive GVD and cause pulse spreading. Further pulse spreading causes self-Phase modulation (SPM) in the Ti:Sapphire rod, which results from the interaction of the short optical pulse with the nonlinear refractive index. In order to obtain stable short output pulses, these effects must be compensated with negative GVD. Prism pairs are used to produce a net negative intracavity GVD in the femtosecond system. This allows the system to produce sub 100 fs near transform limited pulses over most of the wavelength regime.

#### DESCRIPTION OF COMPONENTS

The scheme of Trestles-50 depicted in *Fig. 3* and *Fig. 4* consists of the following optical elements for the basic configuration:

- 1.** 5 mm long Ti-doped sapphire crystal (TiS).
- 2.** Dielectric mirrors M1, M2, M3, M4, M5, M6, M7, M8, M9 with high reflection (>99,5%) for working wavelength, flat mirrors. M1, M2 – have high reflection for working wavelength and transparent for laser pumping radiation, radius of curvature is 100 mm. OC - output coupler; Pm1, Pm2– pump routing flat mirrors.
- 3.** L - lens for focusing of pumping radiation, focal length is F=80 mm.
- 4.** P1, P2 - Brewster angle prisms at 800 nm.
- 5.** A2, A3, A4, A5, A6, A7, A8 – aligning apertures.

We use mirrors M5, M6 in the process of alignment (see alignment procedure). *Option: M5, M6 mirrors are cavity mirrors in the case when your laser has a birefringent filter and you would like to gradually tune the wavelength in CW mode.*

## 4. LIST OF ACCESSORIES

The following conditions or devices are required for assembling, testing and operation of a femtosecond Ti:Sapphire laser :

1. Optical table. Ti:Sapphire laser itself requires about 0.5 m x 0.7 m area of the optical table.
2. A photodiode with  $>10 \text{ mm}^2$  sensitive area or low-inertial power meter for fast control of relative output power in the process of alignment.
3. Power meter for control of output power value.
4. Fast photodiode with 400 MHz oscilloscope to display the temporal structure of output radiation.
5. During aligning (full realigning of the laser) you may need polarizers, we recommend polarization cubes or Glan laser prisms (PC1).
6. Interferometric autocorrelator for the measurement of pulse duration. Time resolution should be better than 10 fs. (We recommend using Del Mar autocorrelator that is completely compatible with the Trestles-50 laser.)
7. A spectrometer operating near 800 nm for spectrum control. (We recommend using Del Mar spectrometer that is completely compatible with the Trestles-50 laser.)
8. Infrared sensor card for observation of weak IR luminescence.
9. We recommend using a chiller to keep the Ti:Sapphire rod at a constant temperature for performance stability.

# 5. INSTALLATION

## UNPACKING YOUR LASER

Your laser was packed with great care and all containers were inspected prior to shipment: the laser left Del Mar Photonics in good condition. Upon receipt of your laser, immediately inspect the outside of the shipping containers. If there is any visible damage to the container, make sure a representative of the carrier company is present when you unpack the laser.

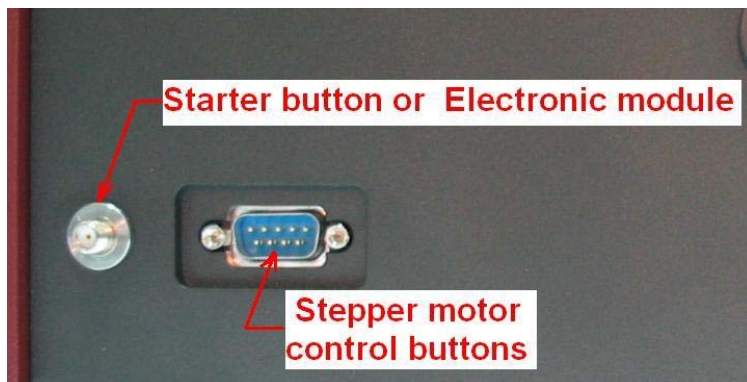
Carefully inspect your laser as you unpack it. If you notice any damage, such as dents, scratches or broken knobs immediately notify the carrier and your Del Mar Photonics sales ([sales@dmp Photonics.com](mailto:sales@dmp Photonics.com)) representative.

Open the cover of the laser head and carefully remove fixing elements which are used for transport, try not to misalign the laser, and damage mirrors during this procedure.

## PLACEMENT OF TRESTLES-50 LASER HEAD

1. Place the Trestles-50 laser head on the table.
2. Adjust the height of the Trestles-50 laser head to the desired height level:
  - Loosen the locking nut on each foot.  
The nuts are threaded onto each leg and jam against the bottom of the base plate to lock the foot in place and to add stiffness to the foot.
  - Wrench the foot to adjust the height so the center of output window (*Fig. 2*) is at the desired height level. Be sure that the main laser breadboard is parallel to the optical table's top.
  - Tighten the locking nuts.

3. Secure the Trestles-50 laser head to the table with the four foot clamps provided.  
The clamps slide over the lower portion of each foot.
4. Verify the height adjust locking nuts on the feet are tight.
5. Hook up the water tubes to the laser head (*Fig. 2*), and switch on cooling water (moderate water flow  $\geq 0.5$  l/min).
6. Connect the Starter button or *Electronic starter* to the laser head (*Fig. 5*). Tap power supply into power line. *Detailed description of this device can be found in section "ELECTRONICS MODULE (Version LS-6.0)" of the current manual*



*Fig. 5*

7. *Optional: motorized slit and prism: Connect the control buttons (small gray box) to the laser head (Fig. 5). Insert the power supply into power line. Detailed description of this device can be found in section "Control Module of The Stepper Motor (SMC245-1v2)" of the current manual.*
8. Turn on the pump laser according to its instruction manual and allow it to warm up.
9. Verify the output of the pump laser meets specifications for power.
10. Reduce pump laser power to the minimum.

## 6. ALIGNMENT

This part of our instructions describes installation and alignment procedure for the Ti:Sapphire oscillator. Researchers use slightly different approaches to constructing a mode-locking Ti:Sapphire laser. If you have good experience in laser technology, you can use your own approach to the alignment of our femtosecond laser. Nevertheless, we hope that our instructions will help you in your work. Alignment procedure consists of two stages. **The first stage** is the alignment of continuous wave (CW) Ti:Sapphire laser. **The second stage** is the transformation of a standard CW configuration into a configuration suitable for mode-locking operation.

### ALIGNMENT OF CONTINUOUS WAVE TI:SAPPHIRE LASER

The laser was factory aligned and under careful transportation conditions you can try to achieve the lasing without full laser realignment. It is not necessary to follow the italicized instructions. You should only carry out these procedures in case of complete laser misalignment under severe transportation conditions. In general, please follow the normally typed instructions.

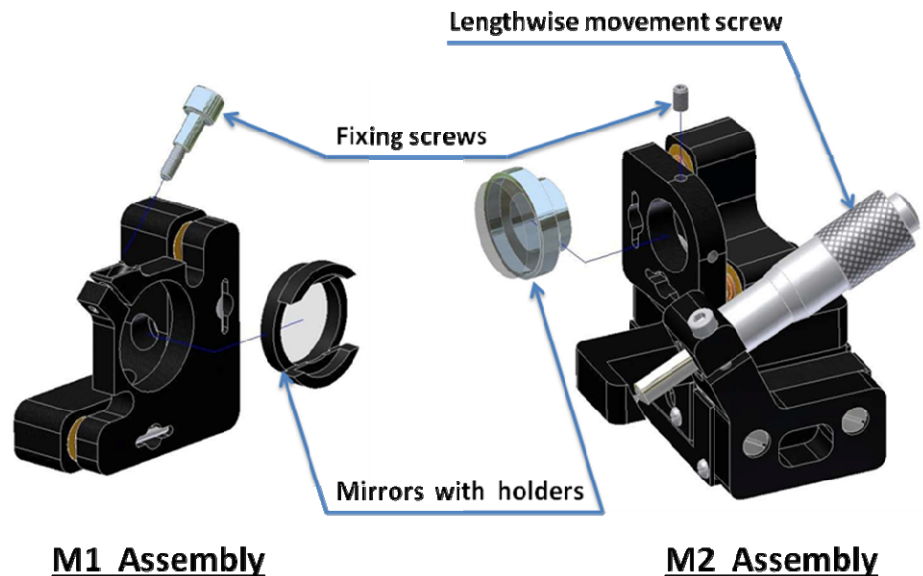
1. Switch on cooling water (moderate water flow  $\geq 0.5$  liter/min).
2. Turn on the pump laser according to its instruction manual and allow it to warm up
3. Reduce pump laser power to the minimum.
4. Screw in all apertures.

5. Verify that the beam pass through the centers of apertures A3, A5 and A2. If not, then use small adjustments of routing mirrors Pm1, Pm2 to route the pump beam to pass through the input aperture A2 and pass through the apertures A5 and A2 inside the laser. You should only carry out these procedures in case of complete laser misalignment under severe transportation conditions.
6. If your laser is equipped with an optional birefringent filter then it is necessary to take it out of the holder (**Fig. 11**). Please be extremely careful not to confuse the fixation screw with the screws that fix the plates of the filter together. If the orientation of the plates changes then the filter will be inoperable. Please refer to Fig. 11.

Again, the italicized instructions are only necessary if laser is completely misaligned. Follow non-italicized instructions **ONLY** the first time through.

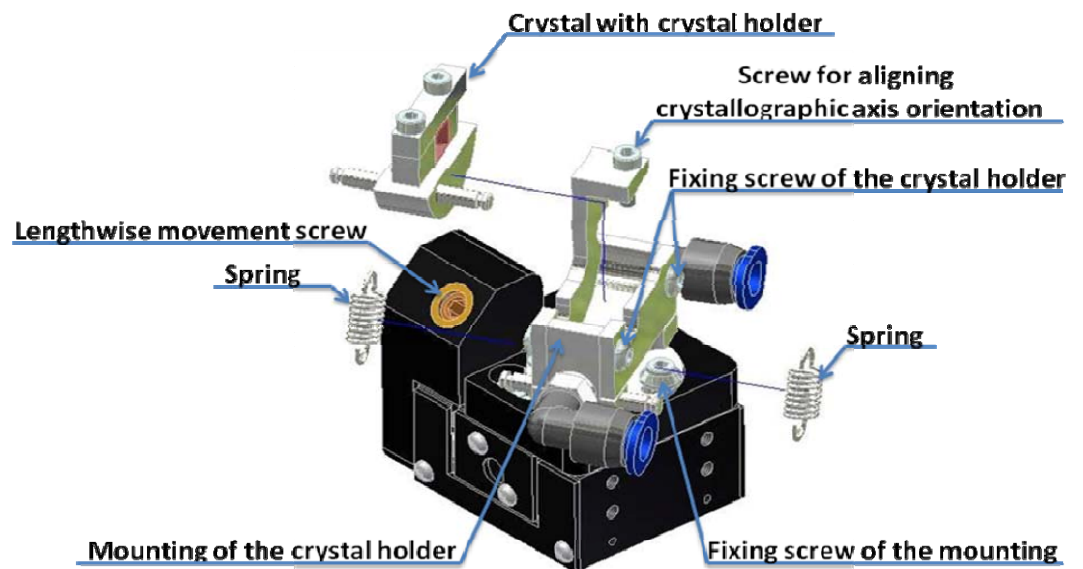
7. Close the shutter of the pump laser.

8. Remove M1 and M2 mirrors with holders from their mounts. (**Fig. 6**)



**Fig. 6 M1 and M2 assembly**

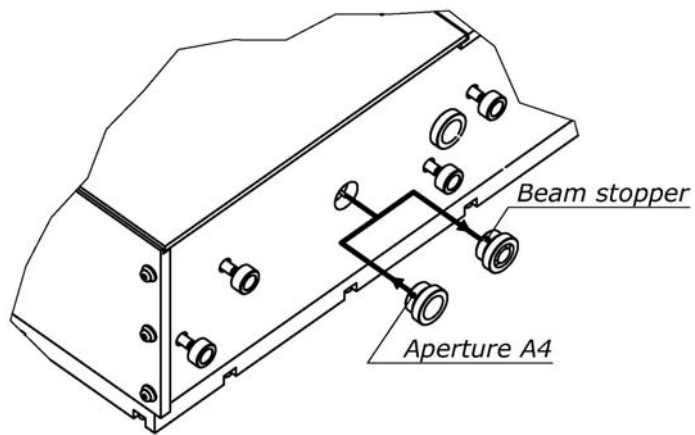
9. Remove focusing lens L with the draw-tube from mount (**Fig. 9**).



**Fig. 7 Cristal mount**

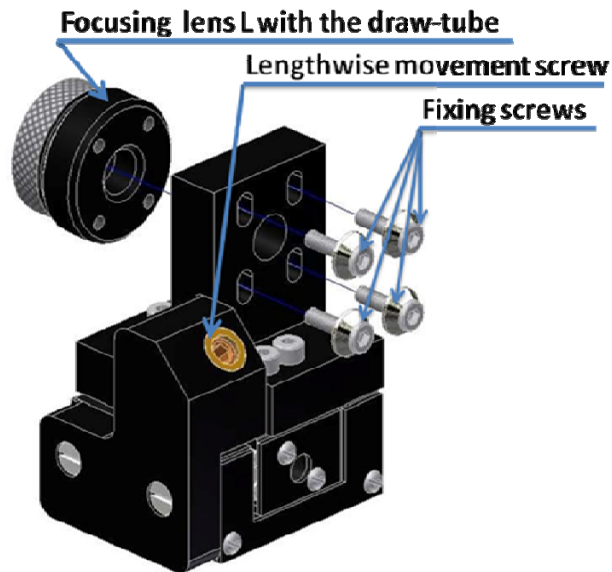
10. Remove the crystal with the crystal holder **Fig. 7**
  - Remove the two vertical springs from the holder using a metallic hook (metallic hook may be easily made from paper clip) or thin-flat-nose pliers.
  - Remove the crystal with crystal holder.
11. Open pump shutter.
12. Verify that the pump beam passes through the centers of A3.
13. Remove the beam stopper and screw in aperture A4 (**Fig. 8**).





**Fig. 8**

14. Direct the pump beam so that it passes through the centers of A3 and A4 apertures.
15. Install the focusing lens with draw-tube back to the lens mount.

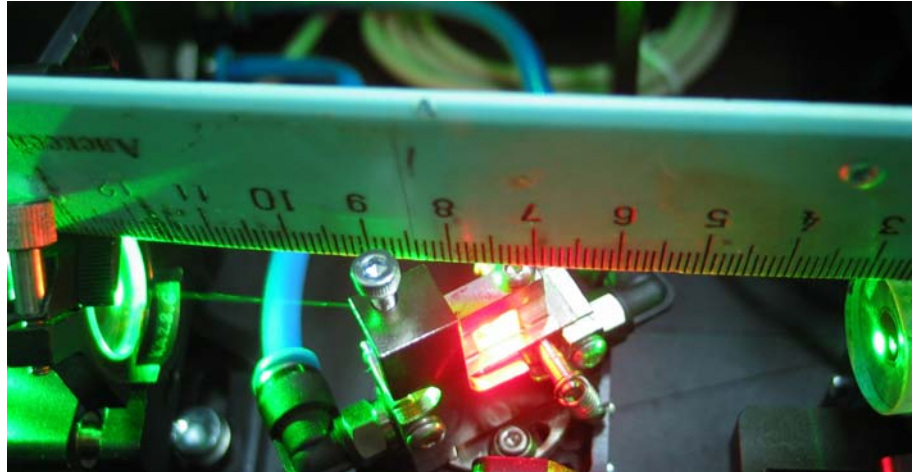


**Fig. 9 Lens mount**

16. Verify that the center of the beam spot on aperture A4 is still on the center of A4.
  - If the centers do not coincide then loosen, but do not remove, fixing screws (**Fig. 9**). Align the position of the lens with the draw-tube and then fix the screws.
  - Verify that the center of the spot is not moving while you are moving the lens forwards and backwards.

17. Close the pump beam shutter.
18. Install M1 mirror with the holder to its mount (**Fig. 6**).
19. Remove A4.
20. Insert the PC1 polarizer in the pump beam beyond the M2 mirror mount. Place the target (piece of paper) beyond PC2. Align the PC2 for a dark "field".
21. Install and align the crystal.
  - Close the pump shutter.
  - Mount the crystal holder to its mount.
  - Tighten two vertical springs.
  - Open pump shutter.
  - Verify that the beam is passing through the center of the crystal.
  - Verify that the beam is passing through the center of the aperture A2. If the beam is not, then loosen the fixing screw of the mount and by rotating the mount of the crystal holder make the green beam reflected from the Ti:Sapphire crystal entrance surface hit the A2. This position of the crystal corresponds to the position at which the green beam intensity is the lowest.
  - Align the crystal for a dark field on a target, rotating the crystal holder around the optical axis using the screw for aligning crystallographic axis orientation (see **Fig. 7**).
  - Close the pump shutter.
  - Set up distance between M2 surface and entrance surface of the crystal to 48-49 mm by adjusting the longitudinal control screw on the crystal stage. Remove PC1.

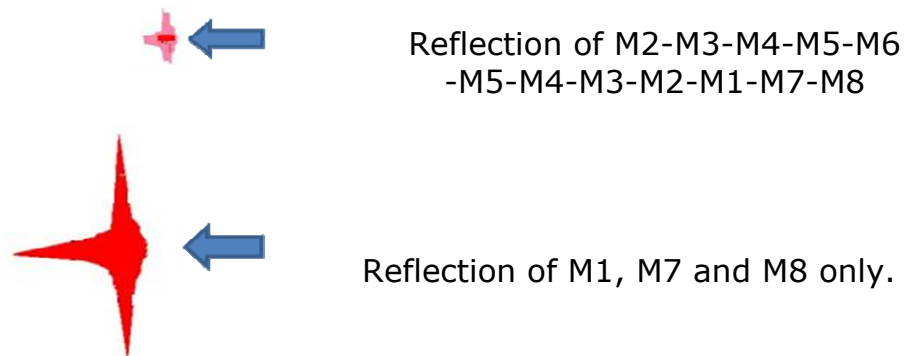
22. Install M2 mirror with the holder to its mount. Set the distance between M1 and M2 surfaces to approximately 103-105 mm (**Fig. 10**).



**Fig. 10** Distance between M1 and M2 surfaces

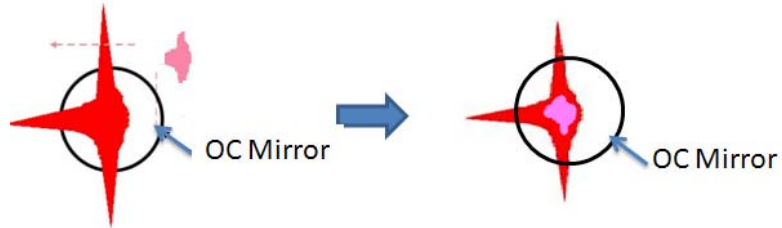
23. Remove aperture A4 and screw in the beam stopper beyond M2 mirror.
24. Remove the blocker from aperture A6.
25. Open the pump shutter. Using insertion adjusting screw of the P1 prism, back the prism out of the beam path.
26. Aligning M2 mirror, direct the residual part of pump beam to the center of the M3 mirror. Verify the height of the beam. (If your laser is equipped with non-adjustable mounts M3, M4, M5, M7, M8, then you need to steer the beam into the center of A5 and A6 apertures by adjusting the M2 mirror. You do not have to carry out the items 26-28 of the current manual either).
27. Aligning M3 mirror direct pump beam to the center of M4 mirror.
28. Aligning M4 mirror direct pump beam to the center of A5 and M5 mirror.
29. Aligning M5 mirror direct pump beam to the center of A6 and M6 mirror.

30. *Aligning M6 direct beam back to the M5, M4, M3 and M2 mirror.*
31. Unscrew apertures A3, A5 and A6 leaving the aperture holders in place.
32. Increase the pump power up to 3-6 W. Use protective goggles for pump laser radiation.
33. *Aligning the positioning of the lens. **Use protective goggles for pump laser radiation during this procedure.** Remove beam blocker, beyond M2. Translating the lens to find the position when round shape of the pump beam will abruptly change to the oval shape. Re-insert the beam blocker.*
34. Use an IR card to see the luminescence near OC mirror.



35. *Aligning M1 mirror, direct luminescence reflected only from the M1 to the center of the M7. (If your laser is equipped with non-adjustable mirror mounts M3, M4, M5, M7, M8, then you need to steer the beam into the center of A7 and A8 by adjusting the M1 mirror. You do not have to carry out the items 35-36 of the current manual either).*
36. *Aligning M7 mirror, direct luminescence reflected from the M1, M7 to the center of the A7 and M8.*
37. *Aligning M8 mirror, direct luminescence reflected from the M1, M7 and M8 to the center of the A8 and OC.*

38. Adjust the position of small spot by M6 controls. The spot should be approximately on the center of spot reflected from M1, M7 and M8.



39. Align OC mirror so the reflected beam returns back to the center of A8, M8-A7 and M7.
40. Unscrew all apertures A2, A3, A5, A6, A7 and A8 leaving the aperture holders in place .
41. If a correct alignment has been made, laser radiation should appear after small adjustments of M6 and OC. If not, then place the additional photodiode with large aperture beyond the OC mirror. The luminescence spot should be in the active area of photodiode. Adjust M6, OC and position of M2 mirrors for maximum signal until generation appears. Remove the photodiode.

42. Place the power meter into the output beam.

43. Adjust the M6 and OC for maximum output power. For optimization of Ti:Sapphire output power adjust OC and M6 by horizontal controls together and vertical controls together also. Output power should be close to the maximum when the spots on M1 look as in the picture below:



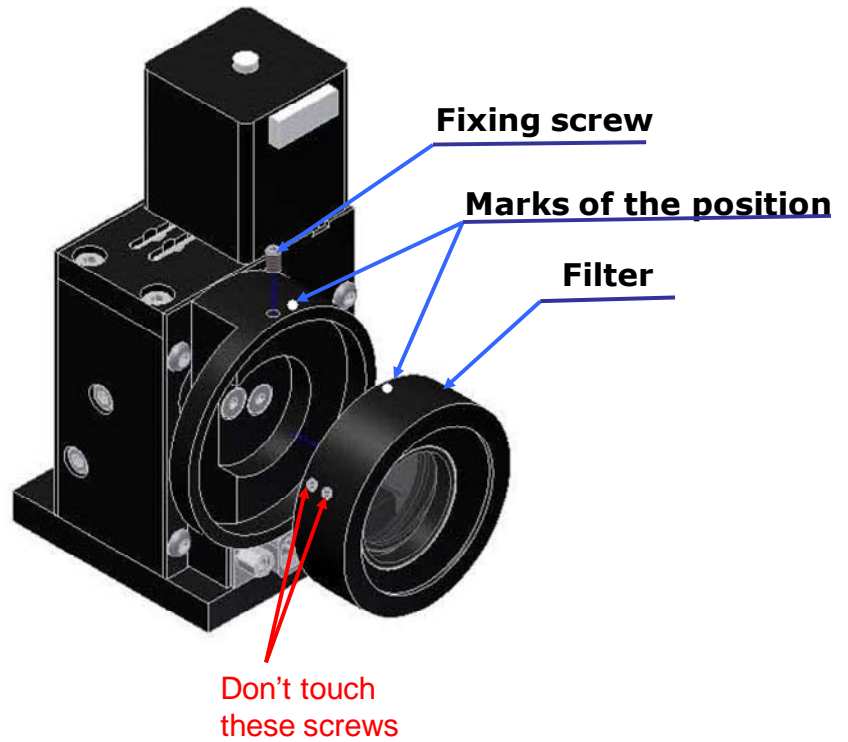
44. By small steps move M2 along the optical axis, try to find maximum output power. Make additional small adjustments using OC and M6 controls after each step.
45. Move the Ti:Sapphire crystal along the optical axis, try to find maximum output power. Make additional small adjustments using OC and M6 controls after each step.

46. Adjust focusing lens position and Ti:Sapphire crystal along the optical axis in small steps. Try to reach maximum output power. Make additional small adjustments using M6 and OC controls after each step.
47. Clean all mirrors in the cavity.
  - Close the pump shutter.
  - Clean one mirror by alcohol or acetone.
  - Open the pump shutter.
  - Verify the output power the value should be bigger or the same.
  - Make small adjustments of M6 and OC to maximize output power.
  - Repeat this procedure for mirrors in the cavity M1, M2, M3, M4, M5, M6, M7, M8, OC, L, Pm1, Pm2, and crystal surfaces.
48. Verify that Ti:Sapphire output power is not less than 10% - 15% of pumping power. If not, repeat steps 42-47. Sometimes, you should repeat these steps several times during the first alignment of the CW Ti:Sapphire laser. It requires patience.
49. Write down maximum output power and position of M2 micrometric screw. Move M2 forward and back and find positions of micrometric screw where Ti:Sapphire laser oscillation disappeared. Write down these positions. This is the range of stability.

*Note. There are two ranges of stability in the asymmetric cavity (see G.Cerulla et. al., Opt.Lett. 19 (1994) 807).*

Option: (in case you have the birefringent filter)

50. Insert the filter back into the holder as shown in **Fig. 11**  
Pay attention to the marks on the filter and its holder. They should strictly coincide.



*Fig. 11 Birefringent filter mount*

51. Connect the filter to the controller as shown in the section "Connection of the Controller" of the current manual.
52. Connect the controller to a PC in accordance with the section "Connection of the Controller" of the current manual.
53. Install the driver if the controller according to "Installing Hardware Drivers" section of the current manual.
54. Install the software (TuneLa) referring to section "Installing TuneLa" of the current manual.
55. Using the TuneLa software set the filter to a position corresponding to wavelength of 800 nm, as indicated in the section "Start TuneLa" of the current manual.

56. Adjust the laser to maximum power as instructed in items 42-46 of the current section. The power should be more than 90% of the initial laser power without the filter inserted.
57. Calibrate the filter for wavelengths according to section "Edit Calibration Dialog Box" of the current manual.



58. Flip the slit aside.
59. Using adjusting screw of the P1 prism insert prism in the beam path. Slowly moving the prism into the beam you can find the position of the prism when laser oscillation begins between mirrors M6 – OC and small fraction of this generation is deviated by P1 prism to prism P2 and mirror M9. (For example: Put the prism P1 to the limit for half of the achieved power in continuous wave, i.e. if the power output in continuous wave mode is 600 mWatts, then put the prism into the beam till you get a reading of around 300 – 350 mWatts on the power meter. In this case the laser generation should be seen near P2).

Again, the italicized instructions are only necessary if laser is completely misaligned. Follow non-italicized instructions ONLY the first time through.

60. *Verify the correct alignment of the prism*
- *Loosen but don't remove the rotation fixation screws R ( **Fig. 12** ).*
  - *Rotating the prism's base plate adjust prism for minimal deviation of the beam ( **Fig. 13** ).*
  - *The heights of the beams should be at the same height as all beams in the resonator. If it is necessary use the adjusting screws to align the prism (see **Fig. 12** ).*
61. Verify that the beam deviated by P1 strikes prism P2. Verify the height of the beam near P2.

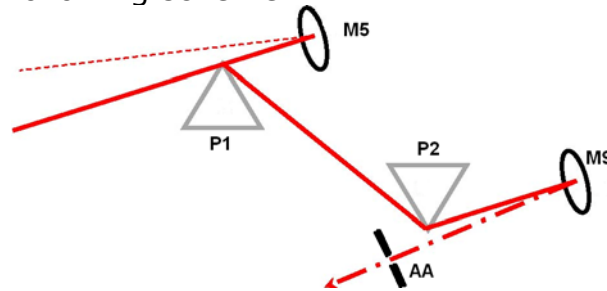
62. Using the adjusting screw of the P2 prism insert prism in the beam path. *If necessary, verify correct alignment of the prism in the same manner as with P1.*

If your laser is equipped with a step motor for P2 prism translation (USB wavelength tuning version) then please also execute the following:

- Connect the step motor to the controller as shown in the section "Connection of the Controller" of the current manual.
- Connect the controller to a PC in accordance with the section "Connection of the Controller" of the current manual.
- Install the driver if the controller according to "Installing Hardware Drivers" section of the current manual.
- Install the software (Motor control program for SMC245-1v2) as shown in section "Installing Motor Control Program for SMC245-1v2"
- Calibrate the device according to section "Calibration of the Device"
- Enter manual mode of the stepper motor control in accordance with section "Manual Mode of the Controller".

63. Align M9 to return the beam deviated by P2 back through P2 and P1 and reach laser generation through the prisms. You can do it as follows:

- Put additional aperture AA (it is included in the laser package) at the front of M9 after P2.
- Reflection of M9 passes near P2 as shown in the following scheme:



- Put AA in line of reflected beam and adjust the height of the beam using the top screw (vertical adjustment) of M9.
- Put P1 and P2 further in the beam completely, by approximately two full turns of the translation screw. Note that generation will stop at this moment.
- Then by adjusting M9 horizontally, try to find small dim reflection of M9-P2-P1-M4-M3-M2-M1-M7-M8 at OC (the same procedure as when adjusting the CW cavity, items 36-41 of the current instructions). Coincide this reflection with bigger one at OC by adjusting M9 screws (reflection of M9 would be very very light, so use Electronic IR viewer or IR sensor card).

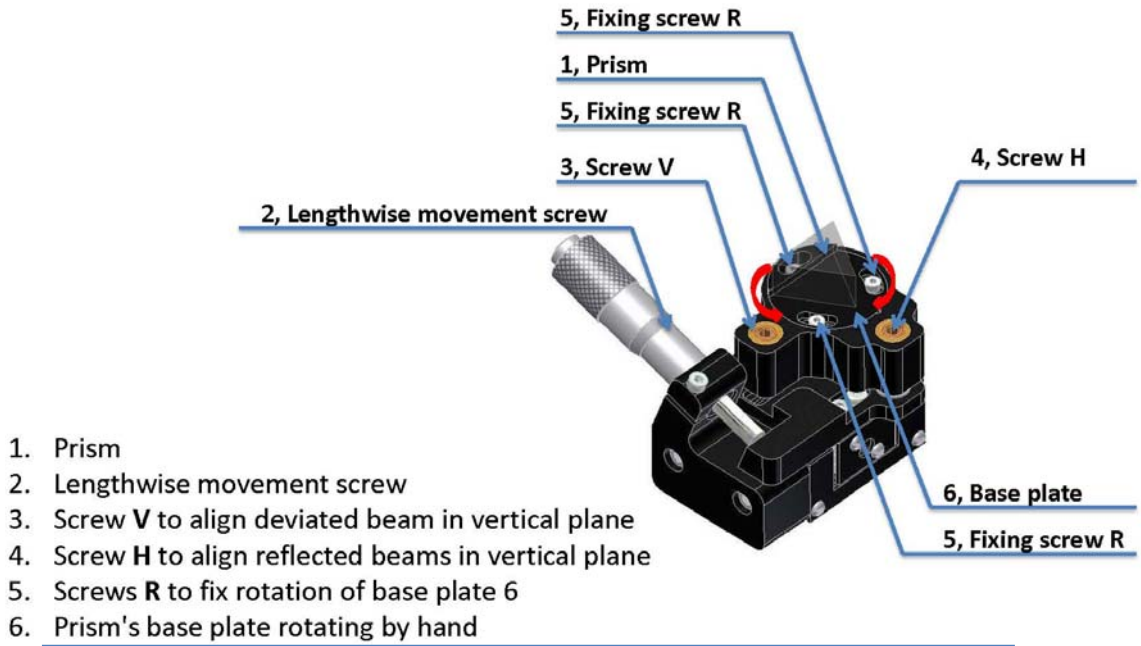
64. Block M6 mirror by the blocker (aperture A5).

65. By aligning OC, M9, M2, lens and a crystal find maximum output power in same manner as in CW operation.

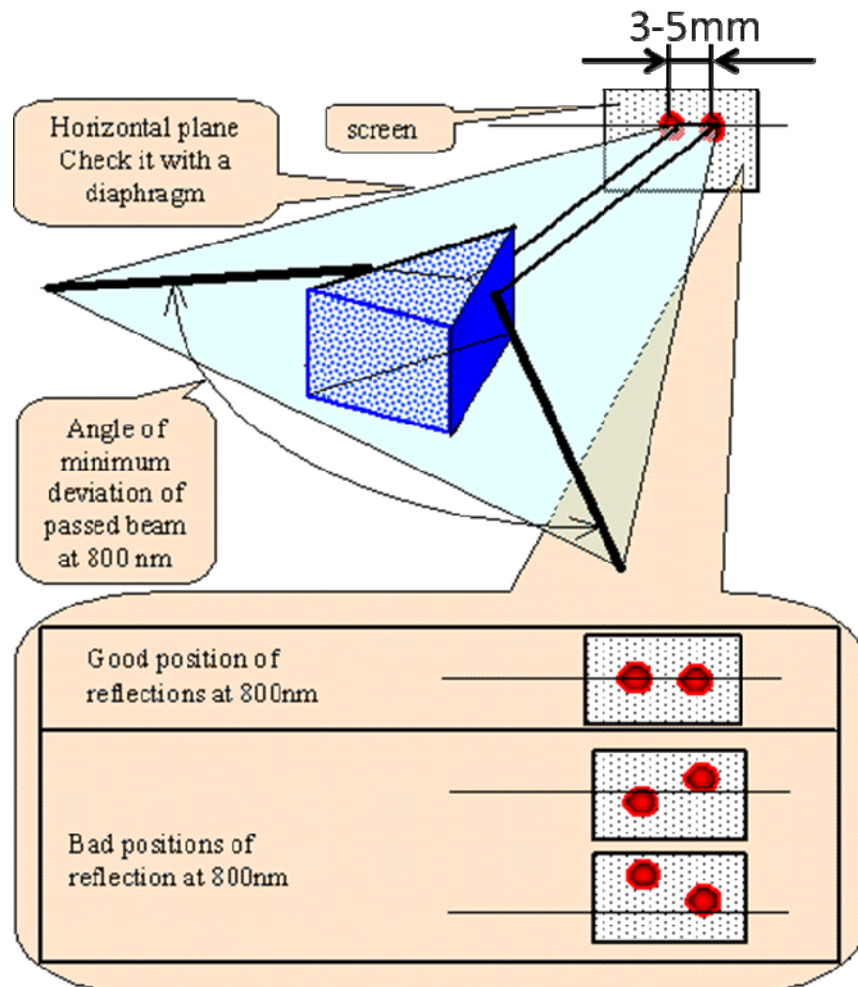
66. **Verify that the output power decreases not more than 15 percent lower than the output power without prisms.** If it does, repeat the procedure of aligning the prism cavity. Sometimes, you should repeat it several times during the first alignment of the Ti:Sapphire laser. It requires patience.

**Note.** After finishing these procedures there are some check points:

1. The spot on the M1 mirror should look like described in item 43. If not align M9 and OC.
2. There are beams reflected from the apex of each prism. The beams must be in cavity plane (the same plane above the breadboard of the laser head, refer to **Fig. 13**). If not then align the prisms and M9, OC to fix it.
3. It's recommended to keep the distance between the beams reflected off the prisms' (P1 и P2) surfaces around 3-5 mm (refer to **Fig. 13**)

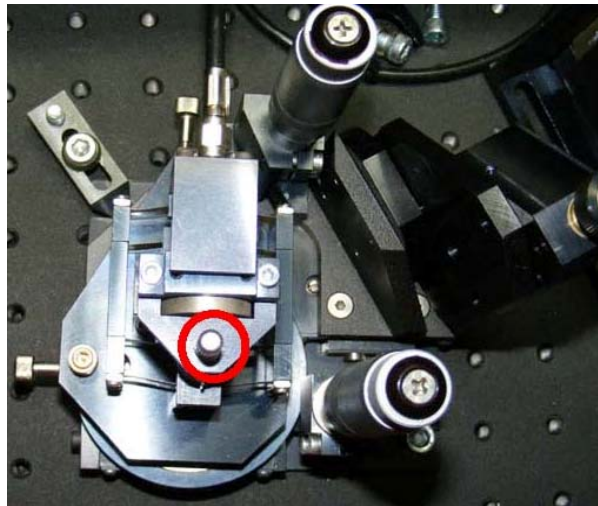


*Fig. 12 Schematic picture of prisms fixation and service*



*Fig. 13 Prisms P1 (P2) alignment.*

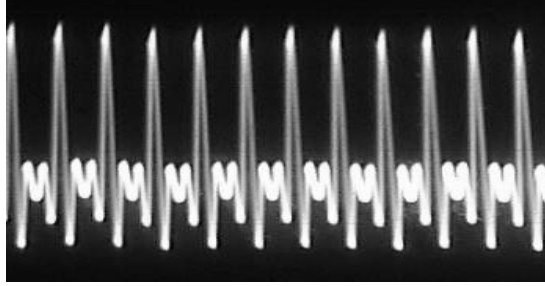
67. Align P1 so that generation is passing almost through the apex of prism. But generation should not be lost. (About 1-3 mm from apex)
68. Test the output beam using fast photodiode and oscilloscope. If the laser has the electromagnetic starter option, then please set it up according to "Electronics Module" section of the current manual.
69. Using the position aligning screw or step motor controller remove P2 out of the beam. The generation will be lost.



*Fig. 14 Prism P2 mount*

70. Move by micrometric screw (or use step motor controller) and slightly push fixating screw of a prism P2 by your finger (marked in *Fig. 14*) (thus you slightly change the depth of insertion of the prism). Look at the result on the oscilloscope. Then by gradually adjusting the M2 find the place where the pulses appear. Femtosecond pulses should appear near the end of the region of stability. Continuous pulse train should be observed on the oscilloscope screen in femtosecond operation (*Fig. 15*).

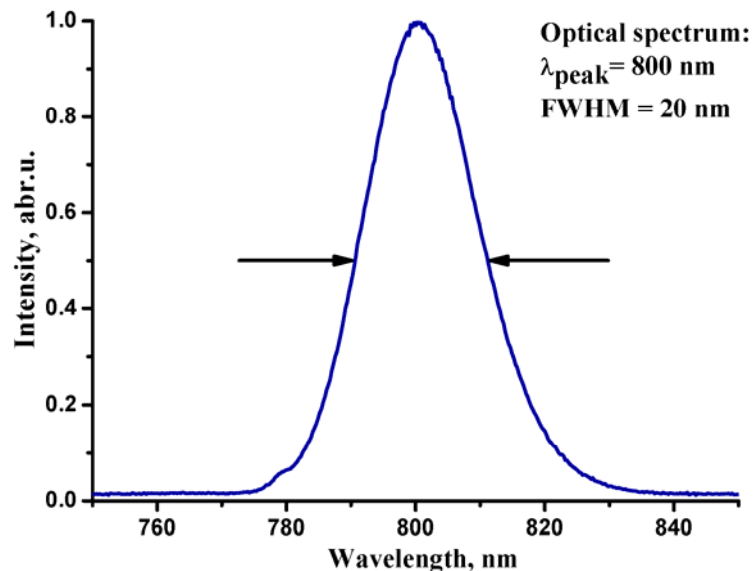
**Note:** Please do not push prism P2 with excessive force.



*Fig. 15 Continuous pulse train*

**Note:** We remind you that two regions of stability exist in asymmetric cavity. You are moving through the stability region having less distance between M1 and M2 than 102-105mm (*Fig. 10*).

71. If you failed to achieve femtosecond mode, try to slightly move the P1 to a different position and repeat the previous instruction step. Sometimes, you should repeat it several times during the first alignment of the Ti:Sapphire laser. It requires patience.
72. Measure the spectrum of Ti:Sapphire laser radiation with the help of a spectrometer or a diffractive grating. The typical spectrum is given in the *Fig. 16*

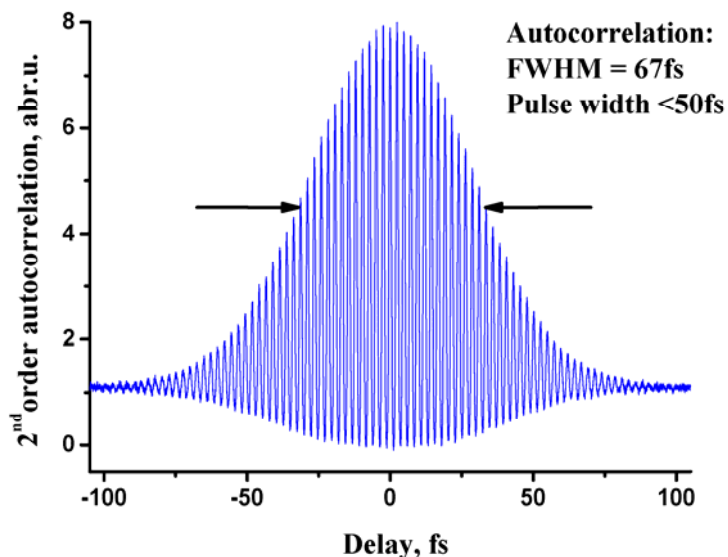


*Fig. 16 Spectrum*

73. Measure the spectrum and try to find its optimum using control of P2 mount. You will obtain shorter pulses with broader spectrum. Spectral bandwidth should not be less than 18 nm at FWHM (full width half maximum) with central wavelength at 800 nm. This corresponds to 50 femtosecond pulse length.

74. Femtosecond operation starts from moving of optical elements. Once started, femtosecond operation should last for hours at good pump laser stability and in stable room conditions ( $\pm 2^{\circ}\text{C}$ ) *Fig. 19*. When femtosecond operation disappears, start it again with mechanical movement of P2 or turn on the [Electronics module \(Starter\)](#).

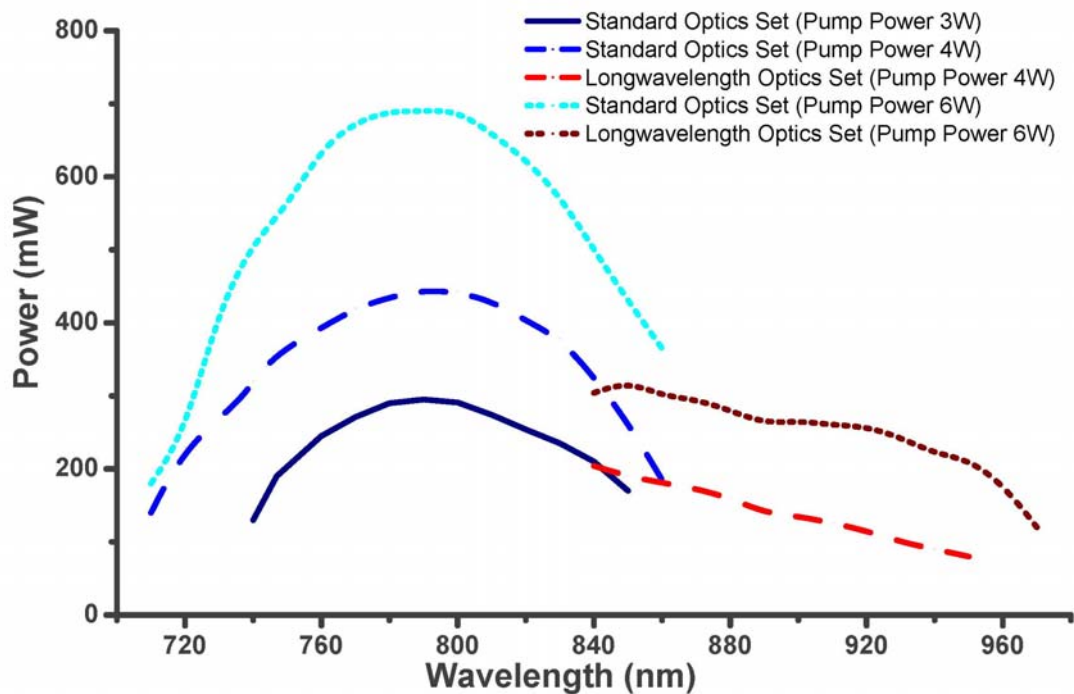
75. Measure pulse duration with an autocorrelator. The typical autocorrelation trace is given in the *Fig. 17*.



*Fig. 17 Autocorrelation*



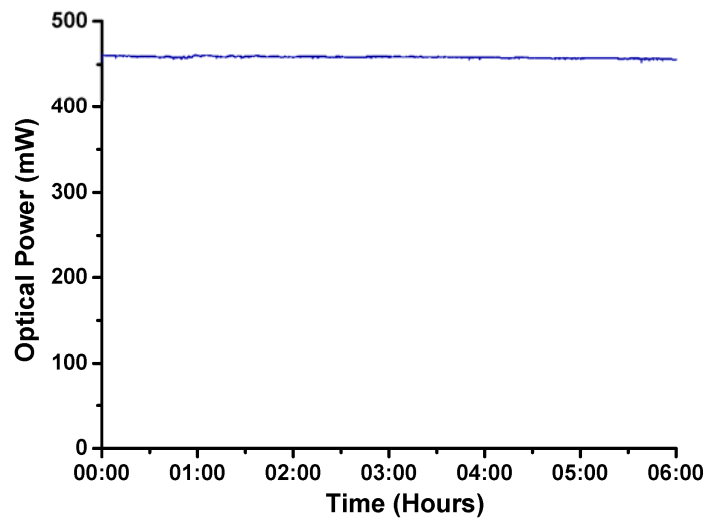
76. To get a tuning of output wavelength (*Fig. 18*) and to control spectral bandwidth, flip the slit back into its place. Align the width and position of the slit so that the pulses easily appear at the same spectral position where they appeared without the slit. Write down the position of the prism and the slit. Then watching the spectrum and "pulse train" move the prism position only (the position of the slit will change also) to shift the pulse spectrum to the desired region. Verify that laser easily starts at new position. Repeat this steps until you reach the desired central wavelength.



*Fig. 18 Turning curves*

## 7. DAY-TO-DAY OPERATION

1. Switch on cooling water for Ti:Sapphire laser.
2. Switch on the pump laser (3-5 W output).
3. Ti:Sapphire will give proper characteristics after 30 minutes of warm-up if you use a standard pump laser. Pump power should be stable from day to day (*Fig. 19*).



*Fig. 19 Stability graph*

4. Small adjustments of M9 and OC might be necessary in day-to-day operation.
5. To turn off the system repeat the procedure in reverse order.

**Note:** Occasionally, it may be necessary to clean the optics and surfaces of the Ti:Sapphire crystal. The best method for cleaning the surfaces is to first block the pump laser beam and then blow excess particles from the surface. Then fold a piece of lens tissue into a pad and clamp with a hemostat (usually provided with the pump laser). Soak this pad with spectroscopic grade acetone or methanol, and shake off the excess liquid. Then make **!one cleaning stroke only!** across the surface (particles on the surface can become imbedded in the tissue and act as an abrasive if a second stroke is made across the surface).

## 8. POSSIBLE PROBLEMS

1. Pump laser output is not TEM<sub>00</sub> mode.
2. Pump laser is not stable enough.
3. Optical surfaces of the laser elements are contaminated.
4. Alignment steps were not performed correctly to reach good femtosecond pulses. Please repeat the alignment. Proper alignment of the Ti:Sapphire femtosecond laser can seem more like an art than science. Stick with it. After a few hours of work you will start to get a feel for the configuration preferred by your laser. Once the full alignment is made, and the laser has not been moved, none or minor adjustments are further required.

***Note:** Pulses shorter than 50 fs were obtained with this laser. However, optimization of femtosecond operation takes time and requires patience. This laser is optimized at 3W-6W pump power.*

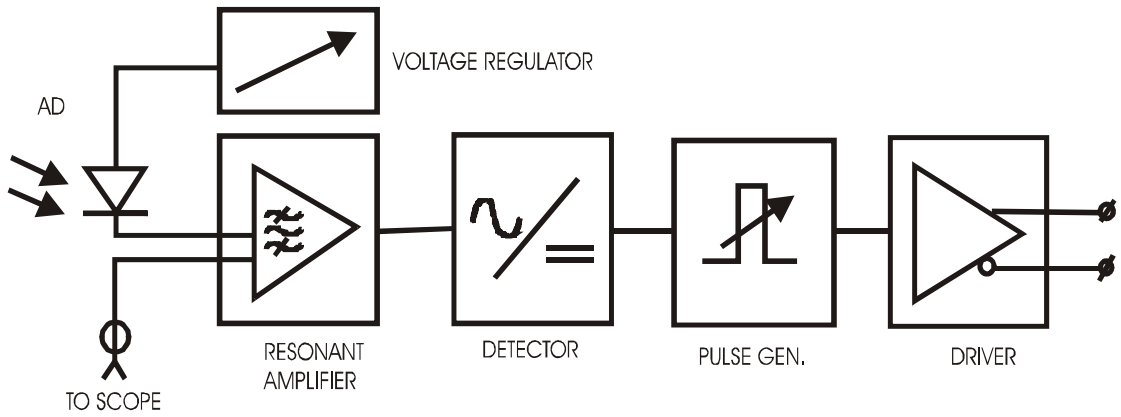
## 9. ELECTRONICS MODULE (Version LS-6.0)

Electronics module LS-6.0 is intended for continuous monitoring of optical signal of mode-locked lasers and disturbing the resonator in case of mode-locking regime breaks down.

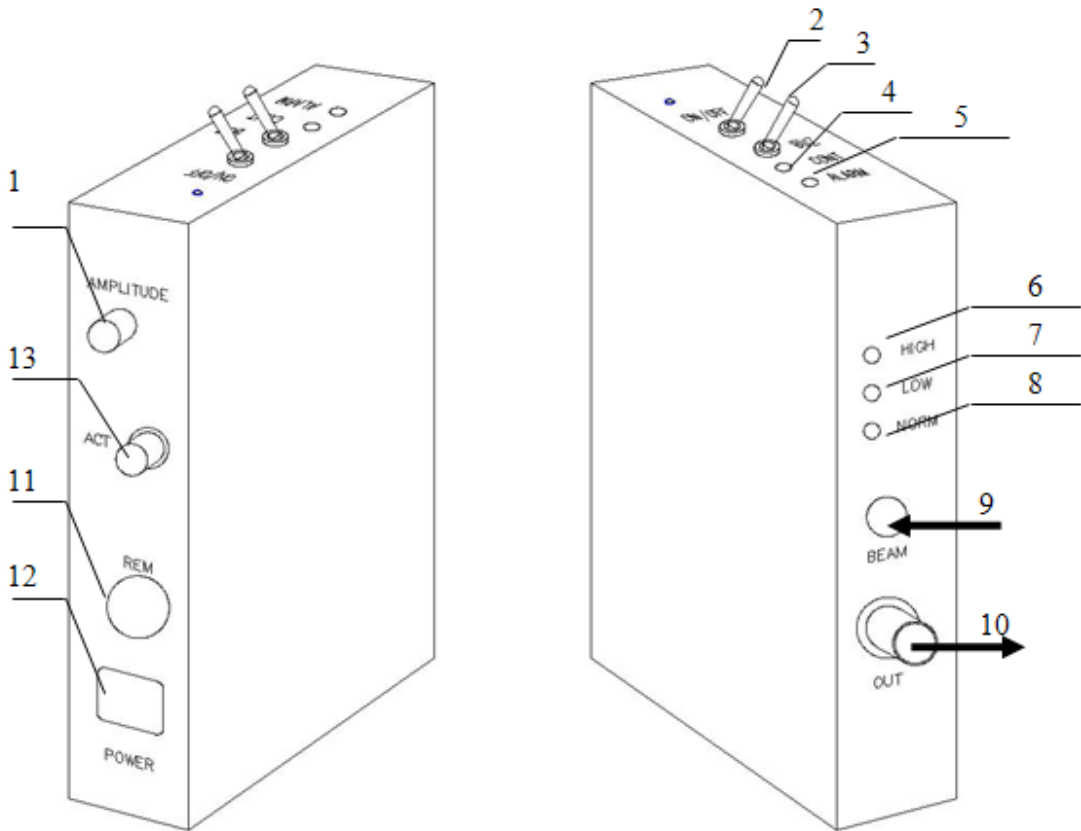
The LS-6.0 consists of a photodiode (*Fig. 20*) powered from the voltage regulator, resonant amplifier, detector, watch-dog timer, one short pulse generator and output driver. Detector output is proportional to first harmonic component amplitude of input optical signal. Central frequency of bandpass filter could be adjusted in the range of 80 - 120 MHz. If detector output is lower than the threshold value for a period longer than 100 ms, single output pulse will be generated. If there is no optical signal on detector, the LS-6.0 will not disturb the resonator.

Pulse amplitude and, consequently, resonator disturbance degree could be adjusted to provide a reliable and smooth mode-locking start-up. Output driver provides 12 V peak output for electromagnetic actuator. RF service output (BNC female connector, 50 Ohm) could be used for monitoring of a photodiode output

***Note: BNC connector must always be loaded with 50 Ohm or connected to the oscilloscope!***



**Fig. 20**

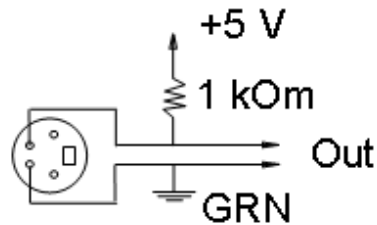


**Fig. 21**

1. "AMPLITUDE" is used for setting the amplitude of output signal (amplitude of mechanical fluctuation).
2. "ON / OFF" - pulse enable switch. When OFF, no output pulse will be produced. If ON, the "CONT" led is on. The signal will be generated if there is no pulse regime. The signal will not be generated if there is no optical signal on photodiode.
3. "BUZ" - Beeper enable switch. Enables sound signal (short beeps) during absence of optical pulse train.
4. "CONT" - green LED "PULSE ENABLE". Indicates actuator driver output enable.
5. "ALARM" - Red LED "ALARM" Indicates an absence of input pulse train (only CW regime).
6. "HIGH" - Red LED. Led is on if the optical power on the photodiode is too high.
7. "LOW" - Yellow LED. Led is on if the optical power on the photodiode is too low.
8. "NORM" - green LED. Led is on when the optical power on the photodiode is normal.
9. "BEAM" - optical beam input. A light spot should be pointed at the center of the photodiode substrate. Sensitive area size is about 1 x 1 mm. Adjust beam position of monitoring signal by a scope.
10. "OUT" - 50-Ohm BNC connector. Photodiode signal output - to oscilloscope.

***Note: BNC connector must always be loaded with 50 Ohm or connected to the oscilloscope!***

11. "REM" -«EXT» - remote status connector. Output optoisolated FET switch is on during absence of optical pulse train (*Fig. 22*).



*Fig. 22*

*Note: When in CW regime the "out" is "high". When in pulsed regime or there is no generation at all the "out" is "low".*

12. "POWER" - Power supply connector

13. "ACT" - Driver output connector - to actuator.

#### INSTALLATION AND ALIGNMENT

1. Place and fix your LS-6.0 on the optical table (*Fig. 23*).
2. Connect a pulse prism actuator to the LS-6.0 using driver output cord.
3. Get femtosecond operation of the laser.
4. Connect the LS-6.0 to DC power supply (+12V).
5. Direct a part of output radiation ( $\leq 10$  mW) to the photodiode of the LS-6.0. At suitable level of light, the green LED "Normal" is on (8 in *Fig. 21*).
6. Connect the 50-Ohm BNC connector (10 in *Fig. 21*) of the LS-6.0 to a 400 MHz oscilloscope.

7. Amplitude of the oscilloscope signal should be about 0.1 V. Use an additional lens to focus radiation to photodiode if necessary.
8. Switch on pulse-enable switch (2 in *Fig. 21*). Green LED "control" (4 in Fig.5.2) lights on.
9. Rotate amplitude adjust (1 in *Fig. 21*) clockwise (i.e. maximize deviation of prism).
10. Cross beam inside the cavity for a short period. Femtosecond operation should appear in a few seconds after that.
11. By adjusting the prism deviation select the best value for femtosecond start.

***Attention! LS-6.0 controls femtosecond operation only at occasional failures. It cannot start mode-locking with unaligned resonator.***



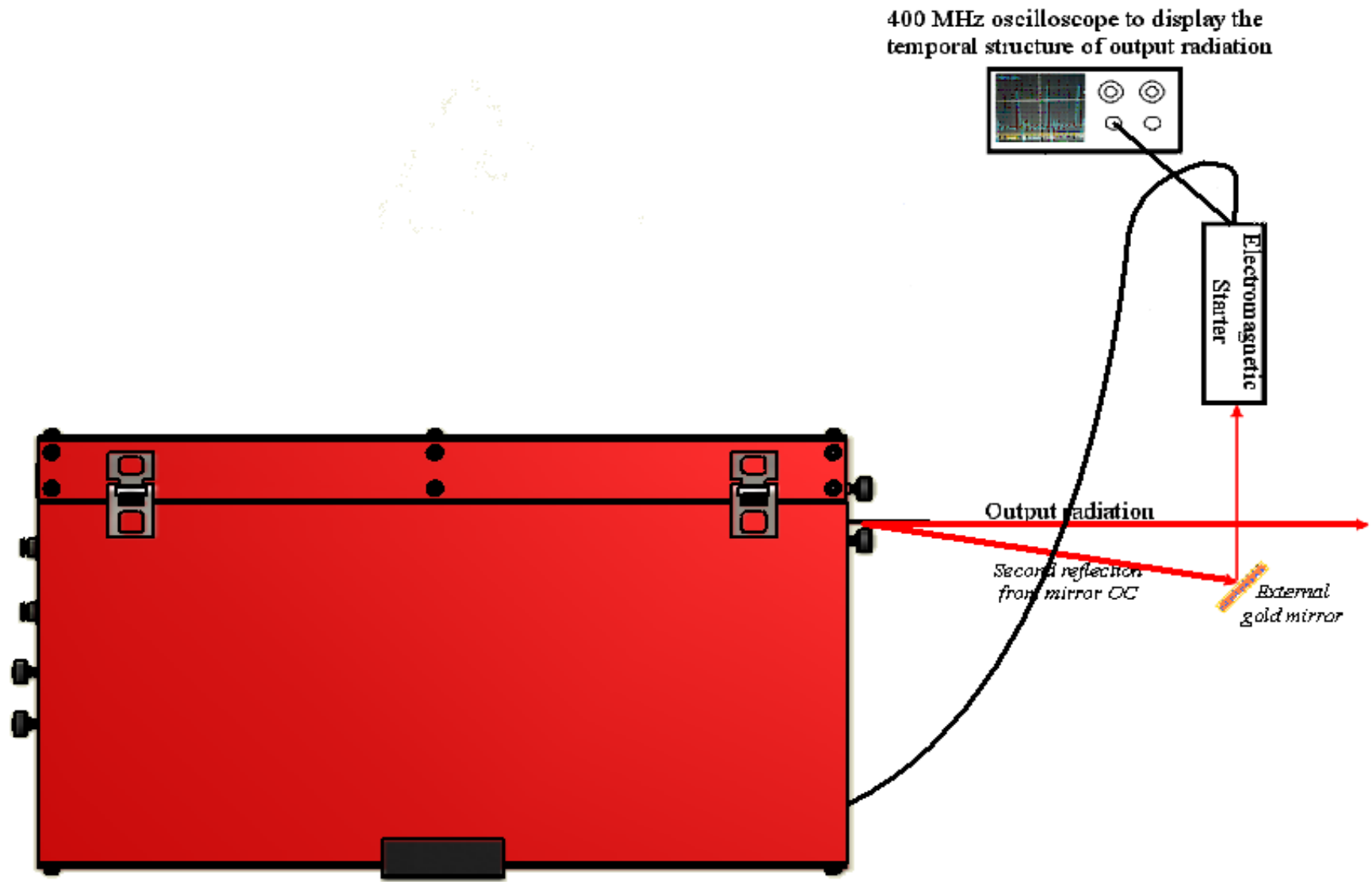


Fig. 23

## 10. General information about the controller

Your laser might have two optional devices that are equipped with step motors. The devices are used for wavelength tuning in CW regime (Lyot birefringent filter) and in fs mode (prism motorized translation stage). To control these step motors a special controller unit has been developed – the SMC245-1V2 controller. These devices allows either manual or PC-controlled operation (USB connection). Each of the motorized laser elements is equipped with two limit switches that limit the translation of the motorized stages.

**Attention!!! The Lyot birefringent filter has optrons i.e. limit switches with normally closed contacts, as when the prism translation stage has normally open contact architecture. Type of the end switches should be chosen only using the software.**

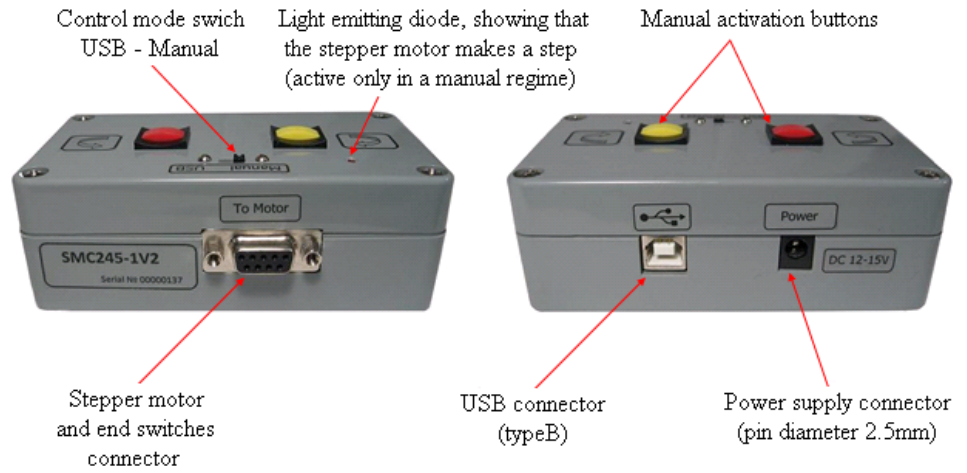
Following functions are to be realized during the PC connection:

- movement in the specified direction;
- changing of the rotation speed;
- determination of possible movement range of the stepping motor with help of the calibration mode; that means the number of steps made by the stepping motor from switching one end switch till switching the other one;
- saving of the set motion speed in the controller memory, as well as the current position and movement range during the work with a preliminary calibrated controller;

The outside view of the controller (from two sides) is shown in the *Fig. 24*. The controller contains the buttons for work at manual mode and the switch on upper panel. Following functions are to be realized during manual mode connection:

- movement in the specified direction;

- saving current position in the controller memory during the work with a calibrated stepping motor.



***Fig. 24 Outside view of the Controller***

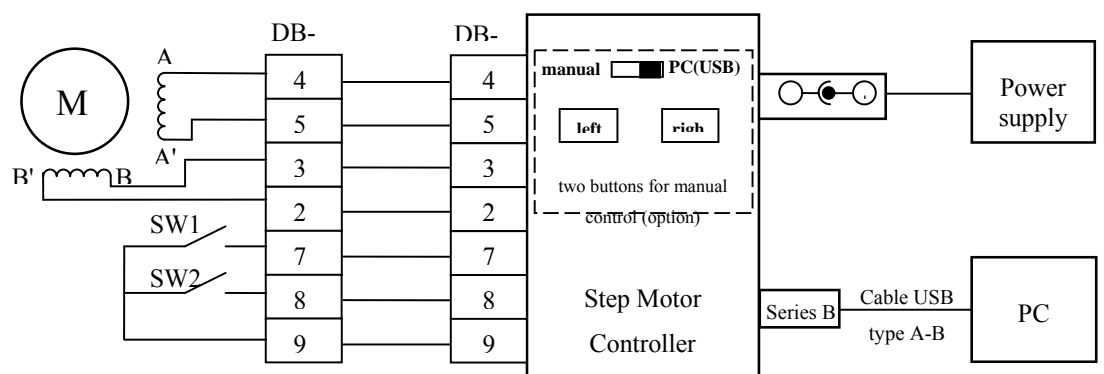
The driver and the operating program “Motor Control Program for SMC245-1v2” are enclosed with the controller. The authors believe that this software has a friendly, intuitively clear interface and allows realizing all possibilities of the controller.

## 11. Connection of the controller

Connect the controller to the laser using the DB-9 cable (enclosed to the laser). The connection scheme is shown at the **Fig. 25**. Connect the power unit to the controller (enclosed to the laser). It is allowed to use unregulated power supply. Supply voltage of the controller is  $7.5 \div 20$  V. Note that if you want to work only at manual mode then the USB connection to your PC is not necessary. If you plan to work in CW mode then connect the Lyot birefringent filter (optional) to the controller, and if you plan to work in mode-locked regime then connect the prism translation stage to the controller.

**Note** (in case the Lyot filter is present in your laser): Be sure to connect and calibrate the controller via PC and software each time you swap between the Lyot filter and the prism translation stage. Then the type of the limit switch and motor calibration is set correctly and you are free to work in manual mode with the given element. If the controller is connected to the other element without further calibration and software connection then it will not work properly until you re-calibrate it through a PC.

The scheme of DB-9 connectors on the front panel of the laser head was given in **Fig. 2** at the beginning.



**Fig. 25** Connection scheme of the Control module

**Attention!!! Supply voltage of the controller must not exceed 20 V.**

## 12. Manual mode of the controller

To operate the controller in manual mode it is enough to connect the controller according the scheme (see *Fig. 25*). However, the connection to the PC is not necessary only if the same wavelength tuning element is used as before (this is important if the laser has optional Lyot filter for CW wavelength tuning). Set the switch on the upper panel of the controller to «Manual». In this mode the step motor is driven when one of the buttons is being pressed. Single input by one of the buttons leads to one-step translation. Holding the button more than 1 second leads to continuous translation with constant speed. The movement may be stopped when the button is released, when one of the limit switches has been activated or when the limit of the possible range has been reached (which is possible only when working with a calibrated device). Each step of the motor is accompanied by a blink of an indicator. At continuous movement the indicator also keeps emitting constantly.

In case the device has been calibrated the current position value is constantly changed during the operation of the motor and the last value is stored into internal memory each time the controller has been idle for 10 seconds after the last motor stop.

The translation speed in manual mode is equal to the value set in PC-controlled mode, by default it corresponds to delay between steps of 20 ms.

The limit switch type and motor winding power supply mode in manual mode are also stored and remain the same as they have been set up during the last PC-controlled connection.

## 13. Description of “TuneLa”.

“TuneLa” is a program that is designed to provide computer-assisted control on wavelength tunable lasers. Up to three stepping motor driven actuators for the spectral selective elements can be accessed via the program GUI. “TuneLa” provides a number of

special functions and options to make operation on tunable laser easy and convenient.

Typically, "TuneLa" is distributed with prebuilt configuration files. These files contain the configuration specific information that gives the program an ability to start immediately after installation with valid settings. If this is not in your case, please check your documentation and read the topic "*Setting Up from Scratch*".

After the startup the "*Main Window*" containing the motors control panel will appear on your desktop. You use controls in the main window and commands from the main menu to operate the stepping motors and tune the lasing wavelength. Please read topics "*Main Window*" and "*Main Menu*" to become familiar with the program interface.

The program needs to be calibrated in order to give you capability to specify the position of the birefringent filter in nanometers. Also you may want to specify the number of steps to move when you press the "*One move*" buttons in each of motor control panels.

The calibration procedure is simple. You have to move the actuator of birefringent filter through the several positions, measure the lasing wavelength, and enter these values in the calibration points list. The order of wavelengths (or the motor positions) is not significant for this procedure. You may start from the center of the current wavelengths range and then return back and record the calibration points on the opposite side.

The program store the calibration data in its profile called "TuneLa.ini". When you start the program next time these data will be loaded and used.

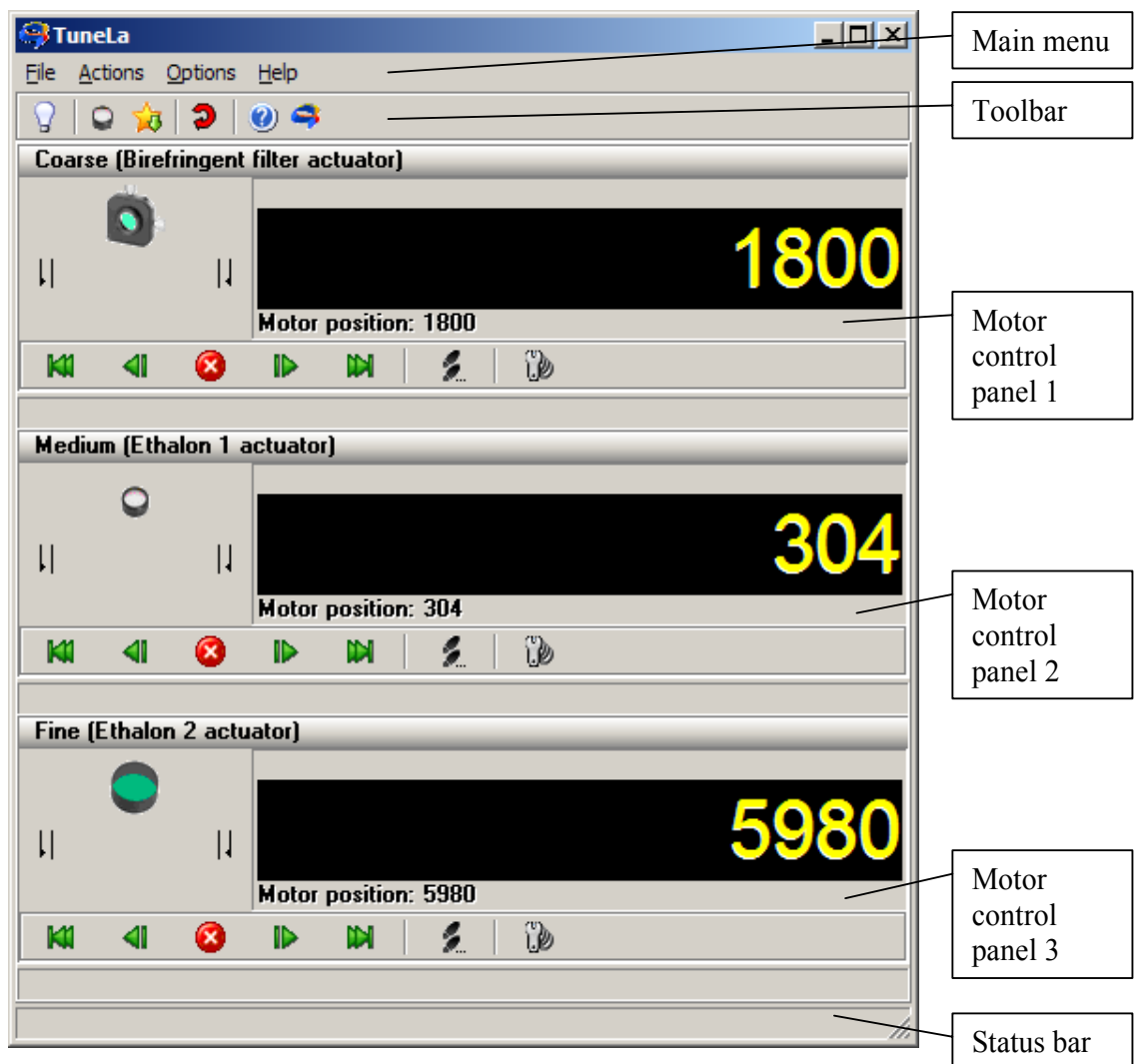
See the "*Stepping Motor Properties Dialog Box*" and "*Edit Calibration Dialog Box*" for more information.

You can record a set of motors positions in a special list of "*favorite wavelengths*" and lately use this list to tune the laser to desired wavelength with one menu selection.

You can tune the etalons to position which provides the maximum output power and record this position. Anytime lately you can easily return to the maximum power position by selecting "*Actions|Set etalons to max power*" command from the main menu of the program.

## Main Window

The main window of "TuneLa" is shown in the figure below. In top of the window there is *main menu* and toolbar. There are three motor control panels in the central area of the window. Each of which is intended for control of one of optical elements used for tuning of a laser generation wavelength. The status bar in bottom of the window displays various status messages and command hints.



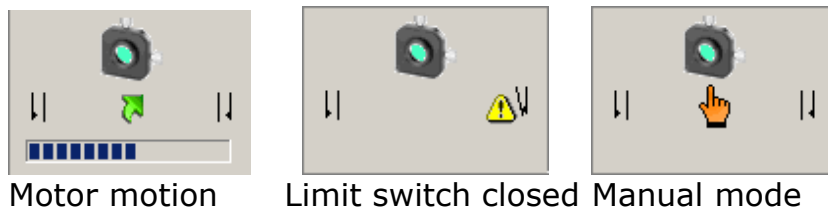
**Fig. 26 Main Window**

## The Motor Control Panel

Each motor control panel consists of four major components: the title bar, the status display at the left, the position display at the right, and the control bar below.

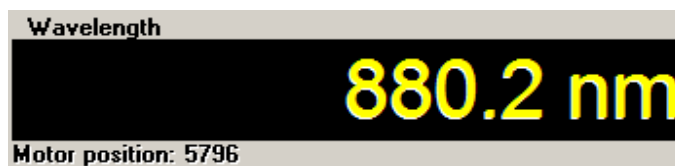
### Coarse (Birefringent filter actuator)

The title bar displays the role of associated optical element in tuning of a laser generation wavelength (Coarse, Medium, and Fine), and the name of this element. Also it has a function of selection the panel for keyboard input (see below).



*Fig. 27 Status display*

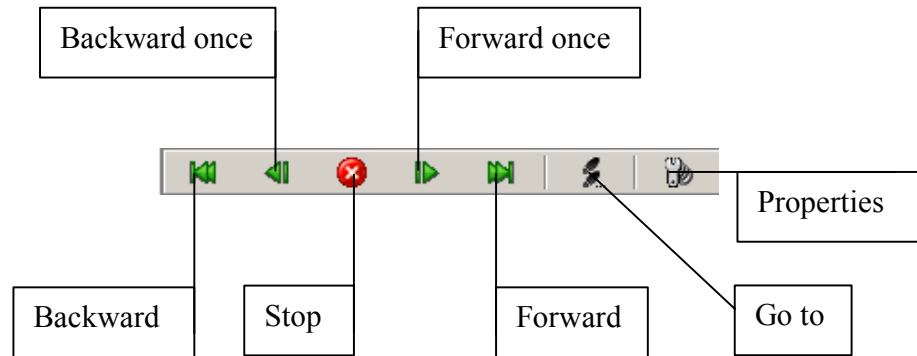
The status display panel displays various states of a given motor as this is shown in the pictures above.



*Fig. 28 Position display*

The position display panel displays current position of a given motor. If the pane has assigned a *wavelength calibration* the big yellow digits will display the value computed from this calibration. The calibrated value is assumed to be in nanometers. If no calibration assigned this display is a motor position in steps. Typically, only birefringent filter can be calibrated. The ethalons are used to fine tune the generation wavelength around wavelength determined by the birefringent filter.





**Fig. 29 The control bar**

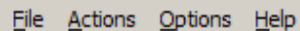
The control bar is used to send commands to a given motor. The buttons has the following functions:

- **Backward** Move the motor to zero position.
- **Backward one** Run the motor backward by certain number of steps. This number can be specified in the "Motor Properties Dialog Box".
- **Stop** Stop the motor motion.
- **Forward one** Run the motor forward by certain number of steps. This number can be specified in the "Motor Properties Dialog Box".
- **Forward** Move the motor to the maximum position.
- **Go to** Run the motor to position specified by user. If a calibration has been assigned to this panel the position is to be specified in calibrated values. Otherwise you have to supply the motor position in steps.
- **Properties** Open the "Motor Properties Dialog Box".

### **Using Keyboard to Control the Motors**

You can use the keyboard to control stepping motors. For activation of this function click the title of desired motor control panel. You use left arrow and right arrow keys to move the motor. The actions of these keys are similar to the actions of the "One move" buttons on the control panel.

You can use up arrow and down arrow keyboard keys to change the selected motor control panel.



File Actions Options Help

The main menu of "TuneLa" provides the access to the most of available commands and actions offered by the program.

The "File" menu item contains the following commands:

- **Exit** Quit the program.

The "Actions" menu item contains the following commands:

- **Set ethalons to max power** This option is available if you registered the maximum power ethalons position. Selecting this item will move the ethalons actuators to positions that you have recorded.

- **Favorite wavelengths** If the "favorite wavelengths" list is not empty the submenu will display the names you have entered for your favorite settings. You may select these menu items to turn the actuators to the positions at which the laser generates your decided wavelength.

- **Wavelengths range** When replacing a set of resonator mirrors to cover a different wavelengths range you should turn the birefringent filter to the position optimal for resonator alignment. To achieve this you use the items in "Wavelengths range" submenu. These menu items are preset by the laser supplier and stored in "TuneLa.ini" file. (For modification of these items see "Setting Up from Scratch").

The "Options" menu item contains the following command:

- **Define max power ethalons positions...**

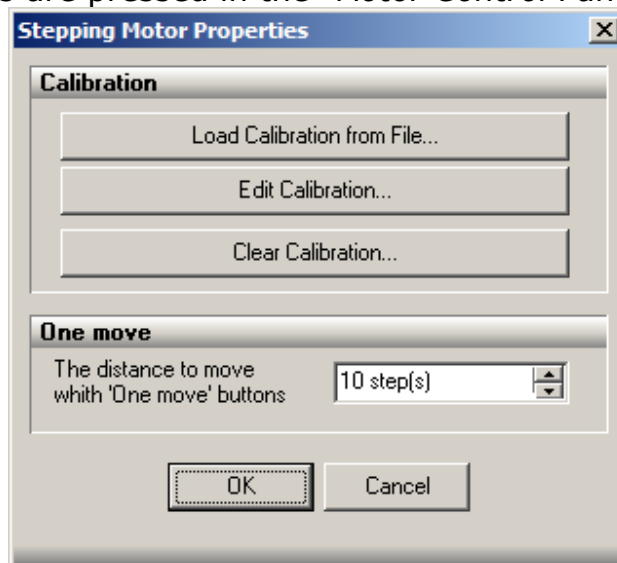
You use this command to register the positions of ethalons corresponding to maximum power of the laser generation. You later use this information to move the ethalons actuators to positions that you have recorded with "Actions|Set ethalons to max power" menu command.

- **Edit favorite wavelengths...** You use this command to open the "Favorite Wavelengths Dialog Box". In this dialog box you can modify the list of your favorite wavelengths to be displayed in "Actions|Favorite wavelengthsI" submenu.

- **Driver setup...** You use this command to open "*Stepping Motors Driver Manager Dialog Box*".
- **Reset driver** You use this command to reset stepping motors driver software in the case of some error.  
The Help menu item contains the following command:
- **Contents** You use this command to asses the on-line help information for "TuneLa".
- **About...** You use this command to display the information about program version and copyrights.

#### Stepping Motor Properties Dialog Box

The Stepping Motor Properties Dialog Box is shown in the figure below. You use this dialog box to manage a calibration data associated with the given motor and to define the distance to move when "One move" buttons are pressed in the "*Motor Control Panel*".



***Fig. 30 Stepping Motor Properties***

You use "Load Calibration File" button to load a calibration data from the file. The file format is as follows:

```
Title line
# Comment line

5 # Number of calibration points followed by points
data (position wavelength)
6233 864.4
8000 801.12
9000 766.28
10000 731.97
11000 697.66
```

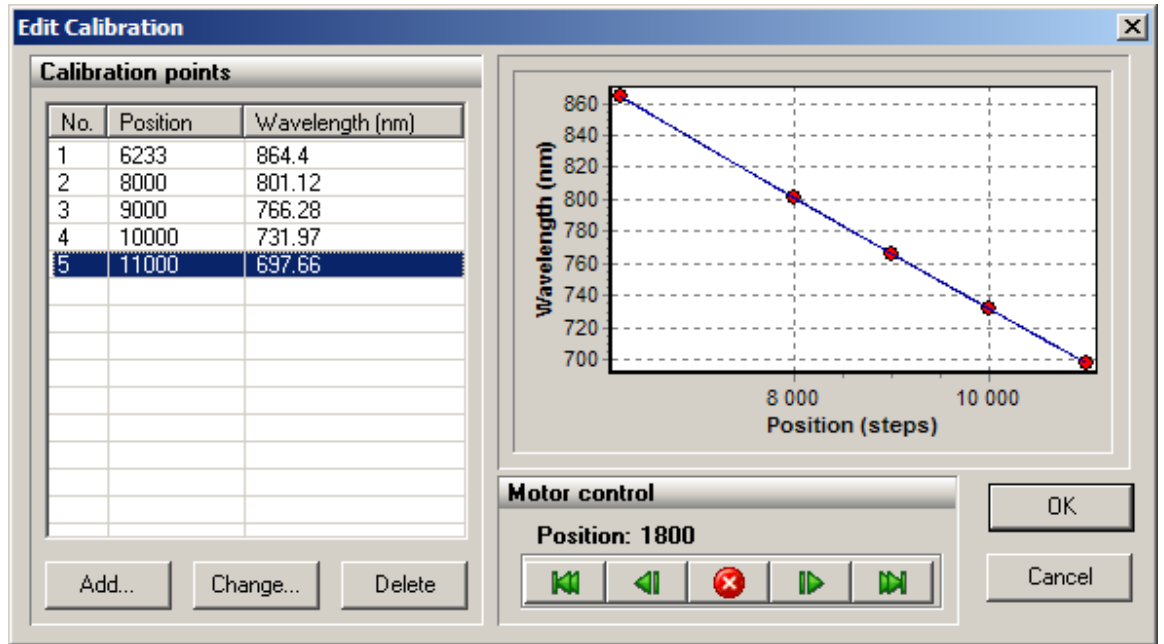
You use the "Edit Calibration" button to open "*Edit Calibration Dialog Box*". In this dialog box you can manually add, remove, and edit the calibration points.

You use the "Clear Calibration" button to remove a calibration assigned to the motor.

You use "One move" numerical input to specify the distance to move when "One move" buttons are pressed in the "*motor control*" panel. The distance is always defined in motor steps.

Edit Calibration Dialog Box

The "*Edit Calibration dialog box*" gives you the possibility to add, remove, and edit the calibration points. This dialog box is shown in the picture below (*Fig. 31*).



**Fig. 31 Calibration Dialog Box**

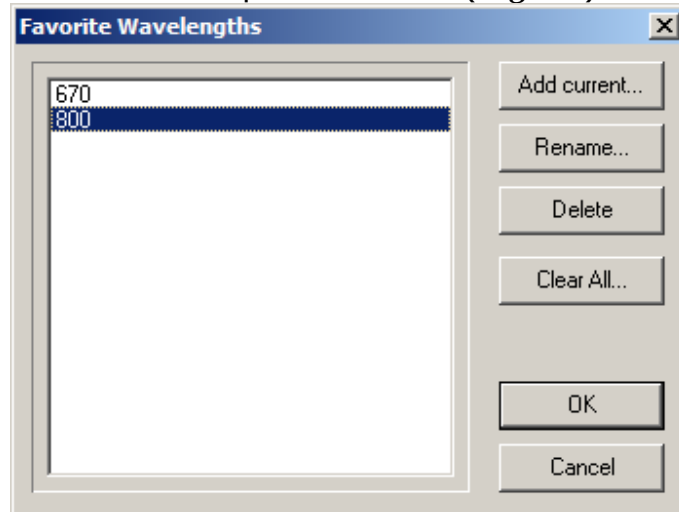
On the left side of the Edit Calibration dialog box there is the list of calibration points and the buttons to manipulate them. On the right side there is the chart showing the calibration points and the resulting calibration curve. The calibration curve is a second order polynomial least square fitted to the calibration points you've entered. The calibration curve must specify an unambiguous relation between motor positions and physical values (e.g. minimum or maximum of 2nd order polynomial must lie outside the range of motor positions).

You use the "Add" button to add a new calibration point to the list. The current position of stepping motor will be automatically inserted in the "*Position input*". You use the "Motor Control" buttons to move the birefringent filter without quitting this dialog box. If you want to delete or modify the value of some calibration point you should select this point in the list and click an appropriate button below.

Press "OK" button to accept modifications you've made. Press "Cancel" button to undo your modifications.

## Favorite Wavelengths Dialog Box

The Favorite Wavelengths dialog box gives you the possibility to add, remove, and edit the items in the "Actions|Favorite wavelengths menu". This dialog box is shown in the picture below (*Fig. 32*).



*Fig. 32 Favorite Wavelengths*

You use "Add current" button to add current positions of motors to the list. By default the wavelength determined by the birefringent filter calibration will be offered as a name of the item. You can modify this default name in the process of addition or any time later.

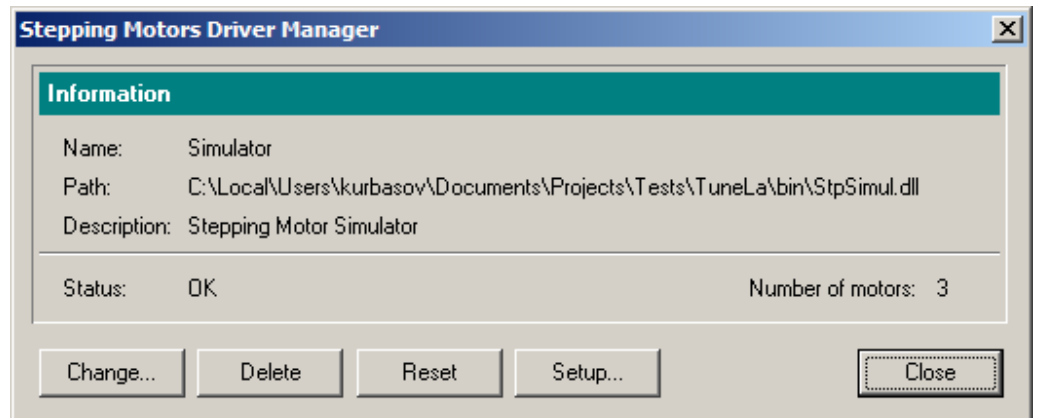
You use "Rename" button to change the name associated with the selected set of motor positions.

You use "Delete" button to remove the selected item from the list.

You use "Clear all" button to remove all items from the favorite wavelengths list.

## Stepping Motors Driver Manager Dialog Box

The Stepping Motors Driver Manager dialog box is designed to control the stepping motors interface DLL used to access the stepping motors. This dialog box is shown in the picture below.



**Fig. 33 Stepping Motors Driver Manager**

In the “*Information panel*” of the “*Stepping Motors Driver Manger dialog box*” you see the name of the stepping motors interface DLL, the path to executable module, and the description of this interface library.

You use the “Load” button to open the interface DLL (If some interface DLL is already loaded this button caption will be “Change”).

You use “Delete” button to unload the interface DLL. (The program will be unable to operate if no interface DLL is loaded).

Currently, you have two choices: the “*StpSimul.dll*” is a simulator library which needs no actual hardware to be connected; the “*Stp1FTDI.dll*” is the library to interact with the real device. Additional options can be included later. Typically, “TuneLa” is distributed with configuration files which specify the “*Stp1FTDI.dll*” as a default interface DLL. For more information see “*Setting Up from Scratch (Advanced topic)*”.

You use “Reset” button to perform software reset. If the stepping motor control unit firmware provides the possibility of resetting, then this command will reset the control unit too. This command is also available in *Options* menu and in the program toolbar.

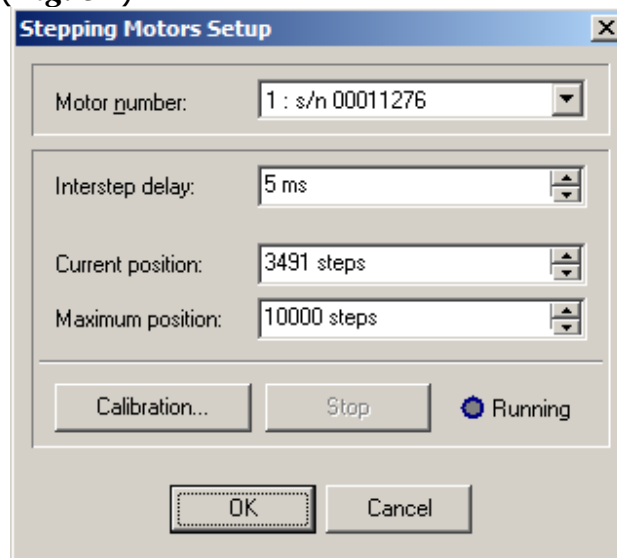
You use “Setup” button to open the “*Stepping Motors Setup Dialog Box*”. In this dialog box you specify the stepping rate for the motors, and perform the motor range calibration.

If the interface DLL supports the configuration procedure (selection of the motors to use and reordering the motors) the button “Reconfigure” will appear in the dialog box. By clicking this button you’ll

open the "Stepping Motors Configuration dialog box". In this dialog box you can specify which motor to use and in what order they should appear in the program.

#### Stepping Motors Setup Dialog Box

The Stepping Motors Setup dialog box is designed to setup some operational parameters for the stepping motors in use. This dialog box is shown in the picture below (*Fig. 34*).



*Fig. 34 Stepping Motors Setup*

You use the "Motor number" list box to select the motor to setup. The motors are presented by their serial numbers as encoded in the controller EEPROM. Please read your system documentation to find out which motor is responsible for which function. Use the "Stepping Motors Configuration dialog dox" to change the motors assignment if it is necessary.

The "Interstep delay" numerical input specifies the motor step rate. (Be sure to close the "Stepping Motors Setup dialog box" with the "OK" button in order the changes to this parameter to take effect).

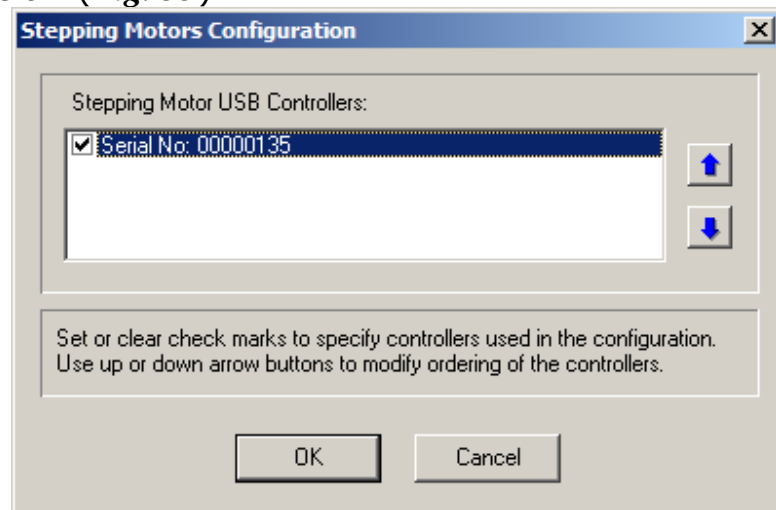
The "Current position" and the "Maximum position" values can be modified by user, but normally they are determined by the motor range calibration procedure. You use the "Calibration" button to start this procedure. During the range calibration the



green LED "Running" flashes. You can stop the calibration by clicking the "Stop" button. After the range calibration is successfully finished the maximum position and the current position is recorded in the control unit EEPROM and will be used for the future operation.

#### Stepping Motors Configuration Dialog Box (Advanced topic)

You use the Stepping Motors Configuration dialog box to setup an appropriate configuration for the compatible stepping motors controllers attached to the system. This dialog box is shown in the picture below (*Fig. 35*).



***Fig. 35 Stepping Motors Configuration***

The motors are represented by their serial numbers. They are initially ordered by accent of this number. You use "Up arrow" and "Down arrow" buttons to move the selected motor in the list. You use check boxes at left of the motor item to specify whenever the program should use this motor.

#### Setting Up from Scratch (Advanced topic)

Typically, "TuneLa" is distributed with prebuilt configuration files. These files contain the configuration specific information that gives the program an ability to start immediately after installation with valid settings. This topic is designed

for the case when you need to setup this configuration from a scratch.

After starting "TuneLa" with no prebuilt configuration files you will need to specify which stepping motor driver interface .DLL to use. To do this you use "Options|Driver Setup" menu command to open "Stepping Motors Driver Manager Dialog Box". In this dialog box you use the "Load" button to select the interface DLL file.

After the interface DLL was selected the "Stepping Motors Configuration dialog box" may appear. Use the supplied documentation to choose which motors to use. The order of motors in this dialog box will determine which motor is assigned to a particular actuator. After finishing this dialog the file "Stp1FTDI.CFG" will be created in the program installation folder.

There are some parameters which can be assigned to a motor. These are the holding current, limit switches type, and margins. In order to provide correct settings you'll need to create a section named [Stp1Settings] in the "Stp1FTDI.CFG" file. The format of this section is as follows:

```
[Stp1Settings]
00011276=0, 0, 50
00011277=0, 1, 50
00011278=0, 1, 50
```

The keywords on the left side are the serial numbers of the motors. There are two Boolean (1/0) parameters you can supply for the given motor. The first is the holding current. If this value is zero the holding current will not be applied to the motor when it is in rest. The one in this position will tell the control unit to hold the motor by applying the current when it is in rest. The second parameter defines the type of the attached limit switches. If this value is zero the switches are closed when non-active. If this value is one the switches are opened when non-active. Check with supplied documentation to setup proper values for these parameters. The third parameter is an integer number specifying the motor motion margin. If its value is zero the motor arrives to requested position moving in backward or forward direction depending on its previous state. If margin is a positive number the motor will go ahead the final

position by that number of steps if moving in forward direction, and then return back. Thus it always will arrive to the requested position moving in backward direction. With negative margin values the logic of operation is reversed and the motor will always arrive to the requested position moving in forward direction. Setting appropriate margins will help to improve the reproducibility of the actuator positioning.

The laser may be equipped with several optics sets. In this case the birefringent filter is set up to operate in various wavelength ranges. In order to be able to easily turn the birefringent filter to the optimum position for a certain wavelengths range you'll need to add the following lines to TuneLa.ini file. In the section named [TLMainWindow] you have to specify how many items you want to add. You use *NRanges* parameter to tell the program about this. Then you should add the specified number of lines with keywords *RangeN* as a parameter name, where *N* is a sequential number of the parameter (starting with zero). The *range* is specified by the two values. The first is a textual representation of this range which will be shown in the program menu. The second is an integer number specifying the position of the birefringent filter for this wavelengths range. An example of these lines is shown in the table below.

<pre>[TLMainWindow] NRanges=2 Range0="680nm - 900 nm", 555 Range1="850nm-1000nm", 777</pre>
---

## 14. Description of “Motor control program for SMC245-1v2”

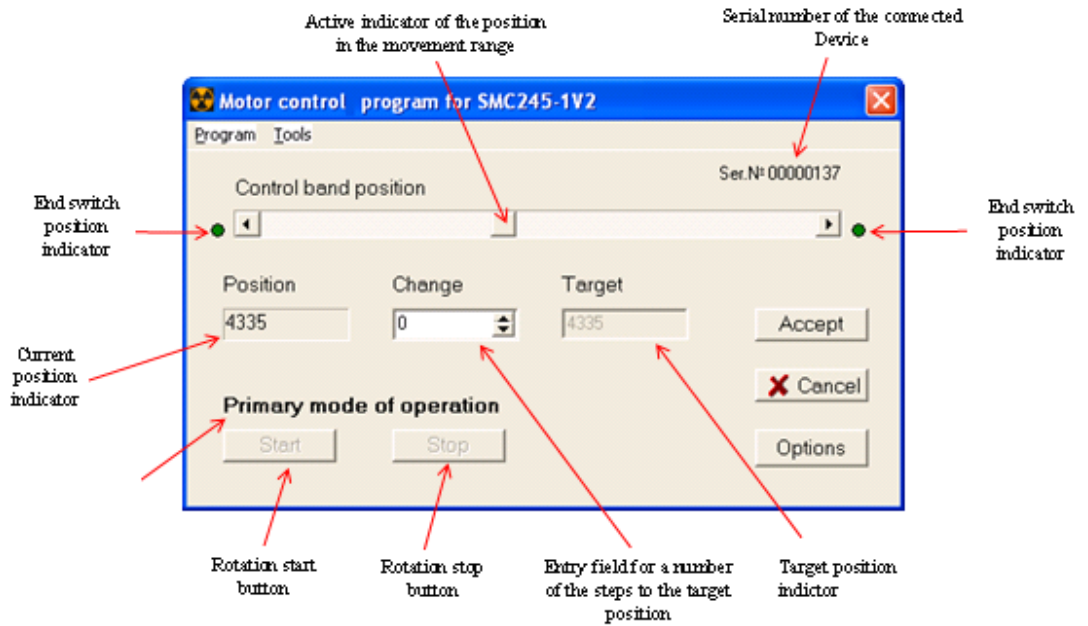
**Attention!!! The program controls only one controller. For correct operation of the controller be sure that the switch is set to PC mode.**

After starting the operation program the window “Stepping motor controls” will appear on the screen as it is shown in the *Fig. 36*.

If the controller is not connected to the PC during start-up the program will issue a warning message “Device is not connected”. In this case connect the controller to the PC and run the command “Connect” in the menu “Tools”.

If the controller is not calibrated a warning message “Not calibrated device. Perform calibration.” will appear. The current position indicator will show 0. Following the further instructions you can calibrate the controller, it means identify a permissible movement range. If you know the movement range and the current position you can enter them by yourself (*Fig. 37*).

**Attention!!! The operating program doesn't allow using the controller till it is calibrated or the range of possible movement and the current position are fixed by the user.**



**Fig. 36 Main Window of the “Motor control program for SMC245-1v2”**

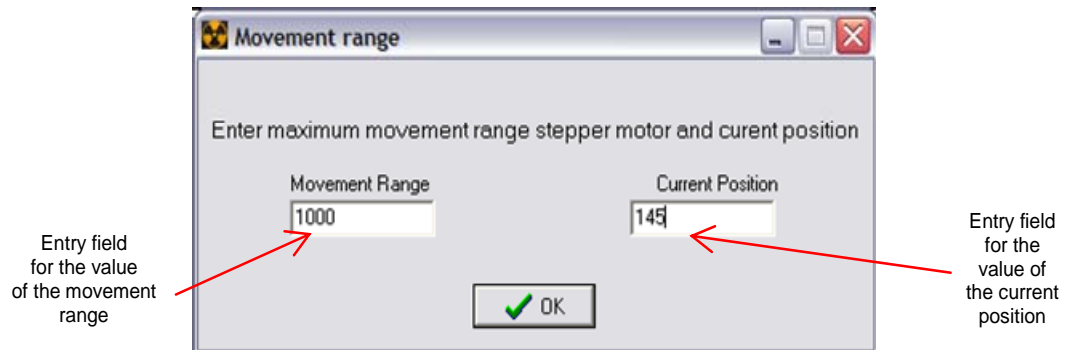
#### Calibration of the Device

To calibrate the controller select submenu “Device calibration” in the menu “Tools”, than run the command “Start”. To stop the calibration select submenu “Device calibration” in the menu “Tools” and run the command “Stop”. After a successful finishing of the calibration a message “Calibration is completed” will appear and the current position indicator will show an end position. If the calibration is not completed a warning message will appear showing a reason of the failure:

- “Device is not calibrated. Left limit switch is not pressed”;
- “Device is not calibrated. Left limit switch is not released”;
- “Device is not calibrated. Right limit switch is not pressed”;
- “Device is not calibrated. Right limit switch is not released”.

To enter the movement range and the current position by yourself, run the command “Movement range” in the menu “Tools”. A window as at the **Fig. 37** will appear. Enter the necessary values in the connecting fields and press the button OK. The result

will be equal as by the successfully completed calibration.



***Fig. 37 Window of setting a possible movement range and the current position***

After the command "Movement Range" is fulfilled or the calibration is successfully completed the value of the possible movement range will be fixed in the controller memory. In case the calibration is not completed or the user stops the calibration, the value of a possible movement range will equal 0.

In case the controller is calibrated but you need to calibrate it again or to use the command "Movement Range", run the command "Memory cleaning" in the menu "Tools". As a result of this command the controller memory will be cleaned and the value of a possible movement range will equal 0.

#### The Motion of the Stepping Motor

To move the mechanism activated by stepping motor to a necessary position, enter its value. There are some ways to do it:

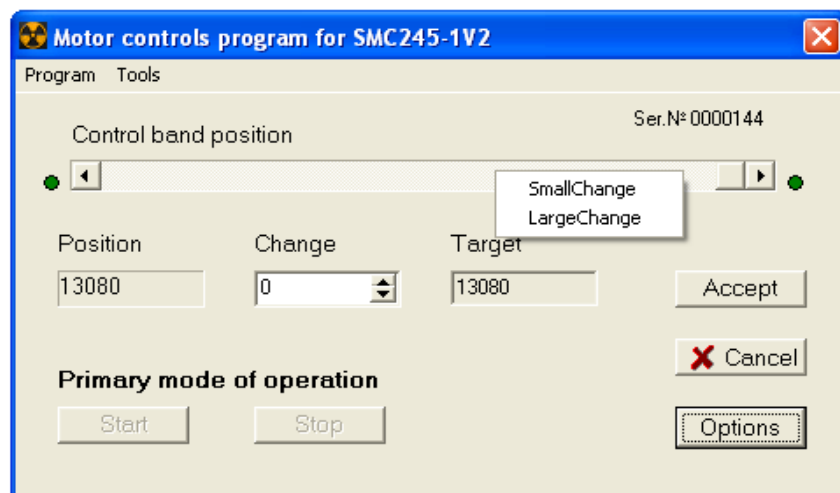
- a) With the help of the mouse move the Control band position indicator to the necessary position;
- b) With the help of the mouse press one of the necessary Control band position buttons;
- c) Click the left mouse button on the Control band position between the indicator and one of the buttons;
- d) Enter the necessary value in the Change position field;

The value of the Target position will change. After the value of the Target position is fixed press the button

“Accept”. You can cancel the settings by pressing the button “Cancel”.

If you want to start the stepping motor press the button “Start”. To stop the motor press the button “Stop”. During the movement the Control band position indicator shows the mechanism position on-line. The movement will stop after the mechanism reaches the set Target position or an end switch switches it off.

Click the right button mouse on the “Control band position” you can change parameters “Small Change” and “Large Change”. See *Fig. 38*.

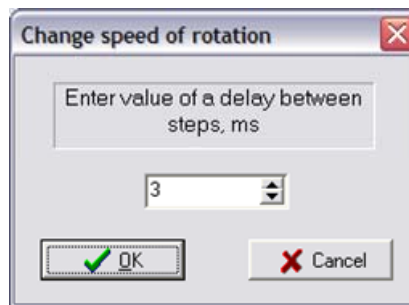


*Fig. 38 Small and large change menu*

The first one determines a value change of the Target position by pressing one of the Control band position buttons. The second one displays the value change of the Target position after clicking the left mouse button on the Control band position between the indicator and one of the buttons.

Positions of the end switches are shown by the corresponding indicators. If they are released they are green, if they are pressed they are red.

The rotation speed is determined by the delay time between steps, default value is 20 ms. You can change it any time, also during the calibration. To do it, run the command “Set rotation speed” in the menu “Tools”. A window will appear as it is shown at the *Fig. 39*.



**Fig. 39 Window of setting the rotation speed**

To change the speed of rotation set the necessary delay and press the OK button. The set value will be saved in the controller memory. The optimal delay between steps is equal 3 ms.

#### Fast Control Mode

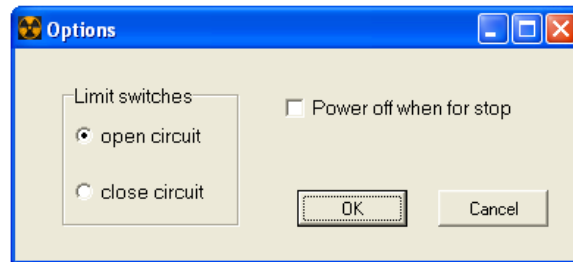
If you mark the field "Fast control" in the menu "Program" you will switch the program into the fast control mode. If you do this the buttons "Start", "Stop", "Accept" and "Cancel" will be non-active. To begin the motion use only Control band position indicator. There are some ways to do it:

- a) Press buttons at the Control band position, the break between steps of the controller will equal to the value of Small Change;
- b) Click the left mouse button at the Control band position between the indicator and one of the buttons, the break between steps of the controller will equal to the value of Large Change;
- c) Move the indicator to the necessary position, the break between steps of the controller will equal to the value of Change position after the indicator is free. If you keep the Control band position indicator the motor will move uninterruptedly in the corresponding direction.

After pressing the button "Options" a window appears which allows choosing the type of end switches and setting the type of windings power supply. This window is shown at the **Fig. 40**. On default the mode is set under which the power supply of the windings doesn't finish by stopping the stepper motor. Note that the type of used end switches (normal-closed / normal-open) can be determined only using the



software. On default the controller is adjusted for the work with normal-open end switches (which are used at prism motion).



***Fig. 40 Options menu***

If messages “Invalid response hardware” or “Unknown error. Please restart Device” appear during using the program, close the program, restore settings by switching off/on the power supply and try again. If these messages appear often please contact the authors of the program.

If messages “Device is not connected” or “Not initialized channel” appear check the power and USB-connection. After solving the troubles run the command “Connect” in the menu “Tools”.

If any other warning messages appear try to solve the troubles if possible. In other case, get in touch with the authors.

# 15. Installing hardware drivers and software

## Installing Hardware Drivers

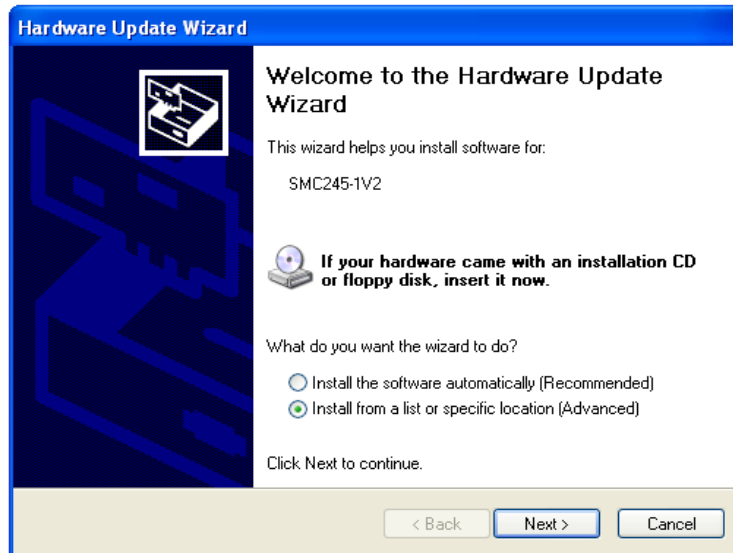
Depending on the type of operational system you have installed onto your PC, there are two mutually exclusive variants of the drivers' setup:

- a) Setup if the device was recognized as "SMC245-1V2"
- Power on the device and connect it to a spare USB port on your PC. This will launch the Windows Found New Hardware Wizard. If there is no available Internet connection or Windows XP SP 2 is configured to ask before connecting to Windows Update, the screen below is shown. Select "No, not this time" from the options available and then click "Next" to proceed with the installation (*Fig. 41*). If there is an available Internet connection, Windows XP will silently connect to the Windows Update website and install any suitable driver it finds for the device in preference to the driver manually selected.



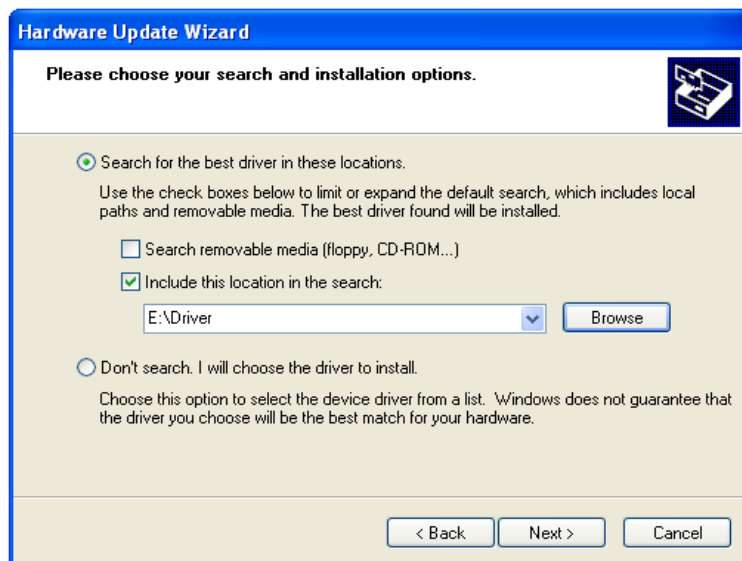
*Fig. 41*

- Select "Install from a list or specific location (Advanced)" as shown below and then click "Next" (*Fig. 42*).



*Fig. 42*

- Select "Search for the best driver in these locations" and enter the file path in the combo-box to the "Driver" folder in your "TuneLa" distribution or browse to it by clicking the "Browse" button. Once the file path has been entered in the box, click "Next" to proceed (*Fig. 43*).



*Fig. 43*

- If Windows XP is configured to warn when unsigned (non-WHQL certified) drivers are about to be installed, the warning screen will be displayed. Click on "Continue Anyway" to continue with the installation (*Fig. 44*). If Windows XP is configured to ignore file signature warnings, no message will appear.



*Fig. 44*

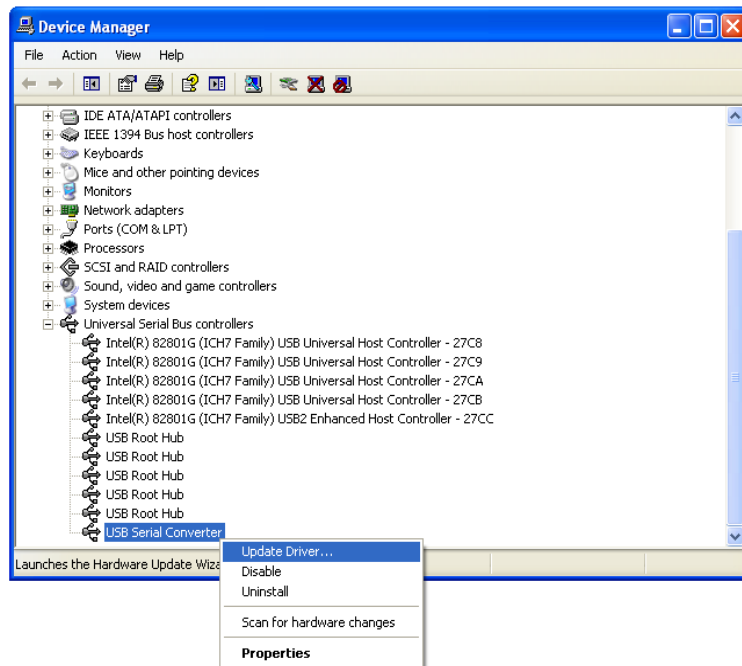
- The progress screen will be displayed as Windows XP copies the required driver files.
- Windows should then display a message indicating that the installation was successful. Click "Finish" to complete the installation for the first stepping motor device.
- You have to repeat the procedure described above for the second and third stepping motors.

Open the Device Manager (located in "Control Panel\System" then select the "Hardware" tab and click "Device Manger") and select "View > Devices by Type". The devices appears as a "SMC245-1V2" connected to a USB port.

b) The PC may recognize the device as "USB Serial Converter"

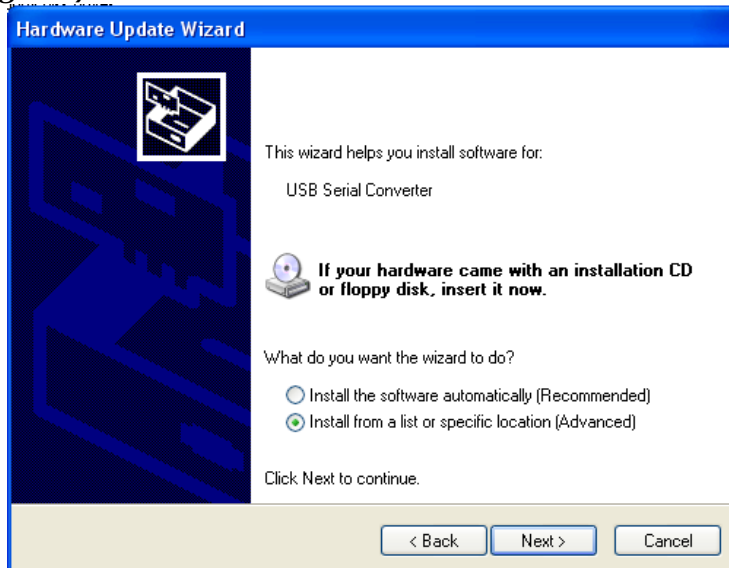
- Enter the "Control Panel/System", then choose tab "Hardware" and "Device Manager".

- In the "Universal Serial Bus Controllers" submenu find the "USB Serial Converter" device. Right-click on this device and choose "Update Driver" (*Fig. 45*).



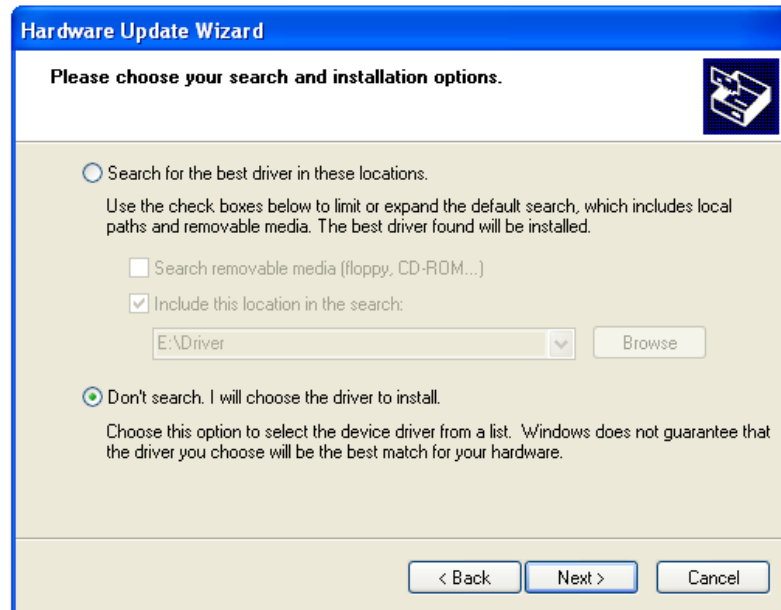
*Fig. 45*

- Select "Install from a list or specific location (Advanced)" as shown below and then click "Next" (*Fig. 46*).



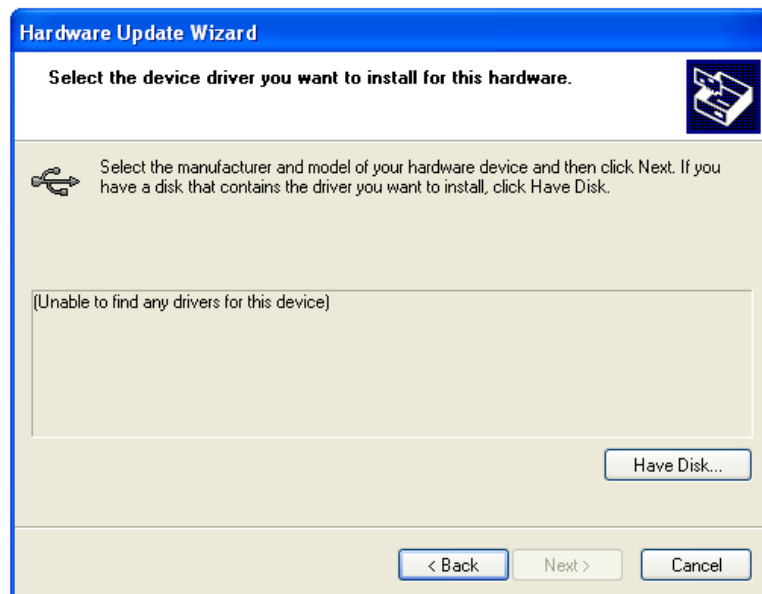
*Fig. 46*

- Choose "Don't search. I will choose the driver to install" и click "Next" (*Fig. 47*).



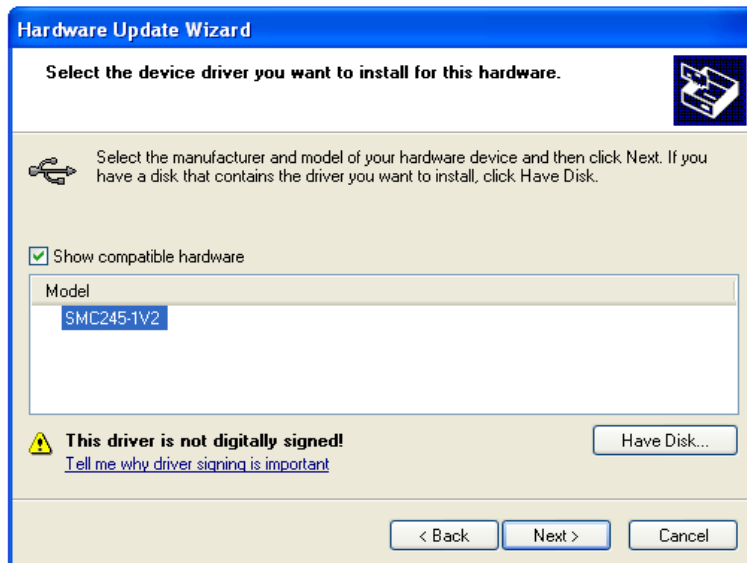
*Fig. 47*

- Choose "Have Disk" (*Fig. 48*). Browse to file "ftd2xx.inf", which is in "Driver" folder on the CD supplied with the laser.



*Fig. 48*

- Choose "SMC245-1V2". Click "Next" (*Fig. 49*).



*Fig. 49*

- If Windows XP is configured to warn when unsigned (non-WHQL certified) drivers are about to be installed, the warning screen will be displayed. Click on "Continue Anyway" to continue with the installation. (*Fig. 50*) If Windows XP is configured to ignore file signature warnings, no message will appear.



*Fig. 50*

- The progress screen will be displayed as Windows XP copies the required driver files.
- Windows should then display a message indicating that the installation was successful. Click "Finish" to

complete the installation for the first stepping motor device.

The device is now ready for use.

#### Installing "TuneLa"

- Make sure that hardware drivers were successfully installed as described in the section "Installing Hardware Drivers", the device is powered on, and connected to the USB port of computer.
- Run "TunelaSetup-1.2.1.0.exe" executable file.
- The Setup Wizard will guide you for the software installation process. Typically, you may accept the default settings offered by the wizard.
- If "Launch TuneLa" option is selected in the last wizard page then "TuneLa" will start automatically after you press "Finish" button.
- Launch "TuneLa" (if it was not started in previous step) using desktop icon created by Setup Wizard or from "Start\All programs" menu. Choose "Help\Contents" menu item in the program main menu.

#### Installing "Motor control program for SMC245-1v2"

- Make sure that hardware drivers were successfully installed as described in the section "Installing Hardware Drivers", the controller is powered on, and connected to the USB port of computer.
- Run "SMC245-1V2.exe" executable file (where 1V2 stands for the software version number)
- The Setup Wizard will guide you for the software installation process. Typically, you may accept the default settings offered by the wizard.
- If "Lunch Motor control program for SMC245-1v2" option is selected in the last wizard page then Motor control program for SMC245-1v2 will start automatically after you press "Finish" button.
- Lunch "Motor control program for SMC245-1v2" (if it was not started in previous step) using desktop icon created by Setup Wizard or from "Start\All programs" menu.



## 16. Start "TuneLa"

- When exchanging the step motors (in case there are more than one in your laser) it is necessary to calibrate the motor each time. Select "Options/Driver Setup" from the upper program menu. Click "Setup" next. (*Fig. 33*). Click "Calibration" (*Fig. 34*). Press "Ok" to finish calibration.
- The Lyot birefringent filter (optional) was wavelength-calibrated at the factory. It will be loaded automatically each time the "TuneLa" is started. To change this calibration select "Properties". Then "Edit Calibration" (*Fig. 30*), and in the next window introduce required calibration curve (*Fig. 31*).  
NOTE: If you are missing the calibration file you can calibrate the filter by yourself (see "Edit Calibration Dialog Box" section)
- Set the birefringent filter to 800 nm, press "Action/Favorite Wavelengths" -> 800 nm.  
NOTE: If you are due to some reason missing values in "Favorite Wavelengths", you can set them up by yourself (see "Edit Calibration Dialog Box" section)



---

---

---



